



DRU LAS

CONCENTRIC FLUE SYSTEMS

Concentric flue
systems for DRU balanced
flue gas fireplaces

i am  since 1754

DRU GAS FIREPLACES

DRU Verwarming B.V. is the largest manufacturer of balanced flue gas fireplaces in Europe, and also produces wood-burning appliances. With a particularly wide range of balanced flue appliances, DRU offers the perfect fit for every living situation.

Installation

Every decorative gas fireplace by DRU featuring balanced flue combustion has its own specific concentric flue system. DRU measures and tests the combination of gas fireplace and concentric flue system together according to strict guidelines. Afterward, the combined system undergoes external testing to obtain the CE marking.

For this reason, and in compliance with legal regulations, DRU gas appliances with balanced flue combustion must be operated exclusively with tested DRU flue materials. Only in this way can proper installation and, above all, safe operation according to DRU installation instructions be guaranteed.

Therefore, DRU supplies a comprehensive range of concentric flue gas materials, which can be divided into the following categories:

- DRU LAS ES-I 150/100 For appliances with a Ø150/100 fitting
- DRU LAS ES-I 200/130 For appliances with a Ø200/130 fitting
- DRU PV-I 100/60 For longer flue gas paths, supported by a PowerVent-02® fan
- DRU LAS ES-E 200/150/100 For installation:
 - Along the outer wall
 - Through combustible building materials
 - Very well suited to well-insulated residences (duct through the wall, ceiling, or roof)

Brochure

For a detailed explanation and overview of available concentric flue systems, we have compiled this brochure for you, with the following important focus areas:

- Available product range, including illustrations, item numbers, and descriptions
- Installation examples, for a comprehensible presentation of installation options
- Working lengths in the item overviews and the installation examples, to provide support in your work preparation, planning, and installation

We are confident that this brochure will help you prepare for and install a DRU gas fireplace. For further information, please visit our website at www.druservice.co.uk or www.druservice.com



Changes and errors excepted. Any exploitation of the information contained here is prohibited without the written approval of DRU Verwarming B.V. The drawings are intended to illustrate potential flue pipe routing. They must not be regarded as a construction manual. The generally applicable building or installation regulations must be adhered to.

TABLE OF CONTENTS



DIN EN 1856-1

SYSTEM PROPERTIES

4



PRODUCT RANGE OF LAS SYSTEMS

DRU LAS ES-I 150/100

DRU LAS ES-I 200/130

DRU PV-I 100/60

DRU LAS ES-E 200/150/100

7



INSTALLATION EXAMPLES

DRU LAS ES-I 150/100

DRU LAS ES-I 200/130

DRU PV-I 100/60

DRU LAS ES-E 200/150/100

20



INSTALLATION INFORMATION

52

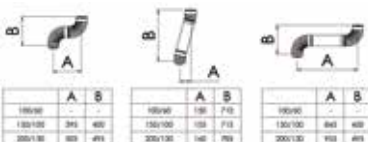

OFFSET TABLES

90° BENDS

45° BENDS

30° BENDS

15° BENDS

54



DRU SERVICE WEBSITE

INFORMATION AND

ORDERING

58

SYSTEM PROPERTIES

General

Balanced flue heating appliances for gaseous fuels are tested in accordance with DIN EN 613, in conjunction with the corresponding concentric flue system (LAS).

DRU balanced flue gas fireplace inserts are category C gas appliances.

They correspond to appliance classification C₁₁, C₃₁ or C₉₁ according to the European legislation:

- C11 Gas fireplaces with horizontal combustion-air supply and flue gas discharge through the outer wall
- C31 Gas fireplaces with combustion-air supply and flue gas discharge vertically through the roof
- C91 Gas fireplaces with combustion-air supply and flue gas discharge vertically through the roof via an existing chimney.

These are gas appliances with a corresponding concentric flue system and without an integrated fan, which discharge the combustion air to the open air outdoors via a balanced flue LAS system.

The pipes are connected together with a sleeve/ribbing push-fit connection. The connection is sealed with a silicone seal. The silicone seal can be used without any problems because the temperature of the supply air does not exceed 180°C, even at flue gas temperatures of 450°C (maximum flue gas temperature of the appliance).

DRU supplies 4 different LAS systems:

- DRU LAS ES-I 150/100 For appliances with a Ø150/100 fitting
- DRU LAS ES-I 200/130 For appliances with a Ø200/130 fitting
- DRU PV-I 100/60 For longer flue gas paths, supported by a PowerVent-02® fan
- DRU LAS ES-E 200/150/100 For installation:
 - Along the outer wall
 - Through combustible building materials
 - Very well suited to well-insulated residences (duct through the wall, ceiling, or roof)

DRU LAS ES-I 150/100

Concentric LAS system made of stainless steel (SST) for appliances with a Ø150/100 fitting.

Material:	SST 304 (some items made of both SST 304 and galvanised sheet metal)
Surface finish:	High-gloss
Wall thickness:	0.40mm
Diameter:	Outer: Ø150mm Inner: Ø100mm
Connection:	Sleeve/ribbing push-fit connection with upper silicone sealing ring and locking band Both components are included with the standard delivery package of each element
Temperature class:	T600 (flue gases up to 600°C permitted).
Norm:	EN-1856-1
Designation:	T600 N1 DVm L20040 050

DRU LAS ES-I 200/130

Concentric LAS system made of SST for appliances with a Ø200/130 fitting.

After a certain distance horizontally or vertically (please see the respective installation instructions for the appliance for the minimum approach distance), this may be reduced to DRU LAS ES-I 150/100.

Material:	SST 304 (some items made of both SST 304 and galvanised sheet metal)
Surface finish:	High-gloss
Wall thickness:	0.40mm
Diameter:	Outer: Ø200mm Inner: Ø130mm
Connection:	Sleeve/ribbing push-fit connection with upper silicone sealing ring and locking band Both components are included with the standard delivery package of each element
Temperature class:	T600 (flue gases up to 600°C permitted).
Norm:	EN-1856-1
Designation:	T600 N1 DVm L20040 050

DRU LAS PV-I 100/60

Concentric LAS system made of galvanised sheet metal (outer pipe) and aluminium (inner pipe) for a wide range of appliances. Please see the installation instructions for the PowerVent-02®.

This system is tested together with the respective appliances and bears a CE marking. Therefore, it does not have its own separate CE marking.

Material:	Aluminium and galvanised sheet metal
Surface finish:	galvanised
Wall thickness and diameter:	Outer: galvanised sheet metal Ø100mm, wall thickness 0.5mm Inner: Aluminium Ø60mm. Wall thickness 1.50mm
Connection:	Sleeve/ribbing push-fit connection with upper silicone sealing ring and locking band Both components are included with the standard delivery package of each element
Temperature class:	Not applicable, appliance-based testing.

DRU LAS ES-E 200/150/100

Thermally insulated, concentric LAS system Ø150/100 made of SST for appliances with a flue gas opening Ø150/100 or Ø200/130 (after reducing to Ø150/100).

After a certain horizontal or vertical distance (with regard to the minimum required vertical length and the maximum permissible length of the horizontal portion, please see the respective installation instructions for the appliance), this may be reduced to LAS ES-E 200/150/100.









This system is designed for:











- Use outside of a building, for example, for a flue gas outlet along the outer wall, or vertically through a pitched roof or flat roof.
- Use in a building, for example, with a duct through combustible building materials or along combustible materials, e.g., in wood-framed houses or through ceilings or roofs with combustible building materials. The clearance to combustible building materials is 0 mm and the duct does not need to be rear-ventilated.
- Very well insulated residences, because the duct must be completely sealed off by the ceiling, wall, or roof (clearance to combustible building materials = 0 mm and the opening does not need to be rear-ventilated).











Material:	SST 304
Surface finish:	High-gloss
Wall thickness:	0.50mm
Diameter:	Outer: Ø200 mm Supply air: Ø150 mm Flue gas: Ø100 mm
Connection:	Sleeve/ribbing push-fit connection with silicone sealing ring inside and locking band Both components are included with the standard delivery package of each pipe element. Flue gas pipe: No seal.
Temperature class:	T450 (flue gases up to 450°C permitted).
Clearance to combustible building materials:	Clearance to combustible building materials is 0 mm, even if the flue gases are at 450°C. Ducts do not need to be ventilated. Locking bands may be installed in the wall.
Standard:	EN 1856-1
CE marking:	EN 1856-1 T450 N1 D Vm L20050 O(00)











PRODUCT RANGE: DRU LAS ES-I 150/100

GLOSS SST FOR INDOOR APPLICATIONS

	Item number	Designation	Working length (m)
	DRU	Pipes straight and adjustable	
	24102	Pipe SST Ø150/100 1000mm	0.95
	24171	Optional: - Pipe galva-SST Ø150/100 1000mm, black	
	24199	- Pipe galva-SST Ø150/100 1000mm, alu-metallic	
	24450	- Pipe SST ø150/100 1000mm, nero	
	24451 24452	- Pipe SST ø150/100 1000mm, titan - Pipe SST ø150/100 1000mm, pearl Including locking band and silicone sealing ring.	
	24103	Pipe SST Ø150/100 500mm, adjustable	0.10
	24172	Optional: - Pipe galva-SST Ø150/100 500mm, adjustable, black	to
	24203	- Pipe galva-SST Ø150/100 500mm, adjustable, alu-metallic	0.45
	24466	- Pipe SST ø150/100 500mm, adjustable, nero	
	34467	- Pipe SST ø150/100 500mm, adjustable, titan	
	24468	- Pipe SST ø150/100 500mm, adjustable, pearl Including locking band and silicone sealing ring.	
	24104	Pipe SST Ø150/100 275-390mm, telescopic	0.28
		Including locking band and silicone sealing ring.	to 0.39
Adaptors			
	24147	Adaptor alu-galva Ø150/100 to Ø100/60	0.10
		Required for an appliance with a flue spigot Ø150/100 with Power-Vent-02®. Not available in SST. Including locking band and silicone sealing ring.	
	62858	Adaptor SST Ø200/130 to Ø150/100	0.09
	24465	Adaptor SST Ø150/100 to Ø200/130 Including locking band and silicone sealing ring.	
Bends, smooth			
	24173	Bend galva-SST 90° Ø150/100, smooth	-
	24202	- black	
	24456	- alu-metallic	
	24457	- nero	
	24458	- titan	
		- pearl Including locking band and silicone sealing ring.	
	24175	Bend galva-SST 45° Ø150/100, smooth, set of 2 pieces	-
	24433	- black	
	24469	- alu-metallic	
	24470	- nero	
	24471	- titan	
		- pearl Including locking band and silicone sealing ring.	
Bends, ribbed			
	24105	Bend SST 90° Ø150/100, ribbed	-
		Including locking band and silicone sealing ring.	











	Item number DRU	Designation	Working length (m)
	24106	Bend SST 45° Ø150/100, ribbed, set of 2 pieces Including locking band and silicone sealing ring.	-
	24136	Bend SST 30° Ø150/100, ribbed Including locking band and silicone sealing ring.	-
	24135	Bend SST 15° Ø150/100, ribbed Including locking band and silicone sealing ring.	-
Bends, segmented			
	24374	Bend SST 90° Ø150/100, segmented, excentric With shortened branch length. Usable on a shortened outer-wall duct, directly behind the appliance Including locking band and silicone sealing ring.	-
	24390	Bend SST 90° Ø150/100, segmented Including locking band and silicone sealing ring.	-
	24391	Bend SST 45° Ø150/100, segmented, set of 2 pieces Including locking band and silicone sealing ring.	-
	24392	Bend SST 30° Ø150/100, segmented Including locking band and silicone sealing ring.	-
	24393	Bend SST 15° Ø150/100, segmented Including locking band and silicone sealing ring.	-
Through the roof (C31)			
	24107	Roof terminal SST, vertical, Ø150/100, black, BD300 Black powder coating RAL9005. Adjustable to a working length of 0.72m Including locking band, silicone sealing ring, and mounting bracket.	0.65 to 1.28
	62862	Roof terminal SST, vertical, Ø150/100, black, BD580 Black powder coating RAL9005. Adjustable to a working length of 1.00m. Including locking band, silicone sealing ring, and mounting bracket.	0.93 to 1.28









	Item number DRU	Designation	Working length (m)
	24235	Extension pipe SST Ø150/100 for roof terminal, L=500, black Black powder coating RAL9005. Including locking band and silicone sealing ring.	0.45
	24108	Chimney top SST Ø150/100, black Black powder coating RAL9005.	0.57
	24406	Optional: - Chimney top SST Ø150/100, unpainted Including locking band and silicone sealing ring.	
	24031	Flat roof tile, 0°, aluminium, Ø430-Ø150	-
	24400	Flat roof tile, adjustable, 0°-25°, aluminium, Ø650-Ø150	-
	24489	Universal tile, lead free, 15°-60°, Ø150	-
Through the wall (C11)			
	24109	Wall terminal SST Ø150/100, unpainted Adjustable to a working length of 0.10m (starting from the outside of the wall). Including locking band, silicone sealing ring, unpainted aluminium rosette 220x220mm, and 4 bolts 4.2x32	0.15 to 0.55
	24174 24462 24463 24464	Rosette Ø150, 220x220mm, painted, - black - nero - titan - pearl	-
	24402	Rosette SST Ø150, 330x330mm, anthracite To cover larger holes.	-
	24375 24376	Rosette Ø156, 220x220mm, painted, for Diablo Next, - black - alu-metallic	-
Through the chimney (C91)			
	24195	Chimney connection SST Ø150/100, with bend 90° Ø100 Concentric pipes individually adjustable Including locking band, silicone sealing ring, unpainted aluminium rosette 220x220mm, galvanised jacketed pipe Ø180mm L=300mm, and 4 bolts 4.2x32	0.17

	Item number DRU	Designation	Working length (m)
	24193	Chimney connection SST Ø150/100, with concentric bend 90° Ø150/100 Length element individually adjustable Including locking band and silicone sealing ring.	0.22
	24142	Flex flue liner SST Ø100, 6m, including adaptor SST Ø100, fixed/flex or flex/flex	6.00
	24141	Flex flue liner SST Ø100, 11m, including adaptor SST Ø100, fixed/flex or flex/flex	11.00
	24475	Inspection piece SST L=266mm for flex flue liner Ø100	
	24422	Adaptor SST flexible Ø100-fixed Ø100	
	24422	Adaptor SST flexible Ø100-fixed Ø100 To connect two flexible pipes (or flexible pipes/exhaust pipes) to each other. Screw the connection elements on side 1: two studs on the SST flexible pipe, on side 2: Drill and screw SST flexible pipe.	-
	24407	Chimney spacer bracket SST for flex flue liner Ø100	-
Wall mounting			
	24194	Wall mounting bracket Ø150 The pipe system must be fixed in place every 2m.	-
Inspection and measurement			
	24453 24454 24455	Pipe galva-SST Ø150/100 1000mm, for inspection, 2 measuring points - nero - titan - pearl	0.22
	24404	Inspection element SST Ø150/100, L=265, straight Including locking band and silicone sealing ring.	
	62859 24378 24379	T-piece SST Ø150/100 L=270, for inspection, with 2 sampling points Optional: - black - alu-metallic Can be used either straight or as a 90° bend. Including locking band and silicone sealing ring.	0.23
	62860 24382 24383	Pipe galva-SST Ø150/100 L=160, with two measuring points Optional: - black - alu-metallic Including locking band and silicone sealing ring.	0.11
	62861 24385 24386 24475	Inspection bend galva-SST Ø150/100 90° Optional: - black - alu-metallic Inspection piece SST L=266mm for flex flue liner Ø100 Including locking band and silicone sealing ring. Outer pipe galvanised.	-





PRODUCT RANGE: DRU LAS ES-I 200/130









GLOSS SST FOR INDOOR APPLICATIONS







	Item number	Designation	Working length (m)
	DRU	Pipes straight and adjustable	
	62851	Pipe SST Ø200/130 1000mm Including locking band and silicone sealing ring.	0.95
	62852	Pipe SST Ø200/130 500mm, adjustable Including locking band and silicone sealing ring.	0.10 to 0.45
	24181	Pipe SST Ø200/130 355-495mm, telescopic Including locking band and silicone sealing ring.	0.31 to 0.45
Adaptors			
	24354	Adaptor alu-galva Ø200/130 to Ø100/60 Including locking band and silicone sealing ring. Required for an appliance with a flue spigot Ø200/130 with Power-Vent-02®. Not available in SST.	0.11
	62858	Adaptor SST Ø200/130 to Ø150/100 Including locking band and silicone sealing ring.	0.09
Bends, ribbed			
	62853	Bend SST 90° Ø200/130, ribbed Including locking band and silicone sealing ring.	-
	62854	Bend SST 45° Ø200/130, ribbed, per piece Including locking band and silicone sealing ring.	-
	24394	Bend SST 30° Ø200/130, ribbed Including locking band and silicone sealing ring.	-
	24395	Bend SST 15° Ø200/130, ribbed Including locking band and silicone sealing ring.	-
Bends, segmented			
	24396	Bend SST 90° Ø200/130, segmented Including locking band and silicone sealing ring.	-





	Item number DRU	Designation	Working length (m)
	24397	Bend SST 45° Ø200/130, segmented, per piece Including locking band and silicone sealing ring.	-
	24398	Bend SST 30° Ø200/130, segmented Including locking band and silicone sealing ring.	-
	24399	Bend SST 15° Ø200/130, segmented Including locking band and silicone sealing ring	-
Through the roof (C31)			
		For further construction through the roof, see LAS ES-I 150/100	
Through the wall (C11)			
	62855	Wall terminal SST Ø200/130, unpainted Adjustable to a working length of 0.10m (starting from the outside of the wall). Including locking band, silicone sealing ring, unpainted aluminium rosette 300x300mm, and 4 bolts 4.2x32	0.15 to 0.55
Through the chimney (C91)			
		For further construction through the chimney, see LAS ES-I 150/100	
Wall mounting			
	24196	Wall mounting bracket Ø200 The pipe system must be fixed in place every 2m.	-
Inspection and measurement			
	24405	Inspection element SST Ø200/1300, L=265, straight Including locking band and silicone sealing ring	0.22
	62856	T-piece SST Ø200/130 L=270, for inspection, with 2 sampling points Can be used either straight or as a 90° bend. Including locking band and silicone sealing ring.	0.28
	62857	Pipe SST Ø200/130 L=160, with two measuring points Including locking band and silicone sealing ring.	0.12
	24182	Inspection bend SST-galva Ø200/130 90° Including locking band and silicone sealing ring. Outer pipe galvanised.	-

PRODUCT RANGE: DRU PV-I 100/60
POWERVENT-02[®] SYSTEM

	Item number DRU	Designation	Working length (m)
	24176	Pipe alu-galva Ø100/60 2000mm (for dry spaces)	1.95
	24177	Optional: - Pipe alu-galva Ø100/60 2000mm, painted anthracite For wet spaces/crawlspace (must not be continuously exposed to moisture) Including locking band and seals.	
	24148	Pipe alu-galva Ø100/60 1000mm (for dry spaces)	0.95
	24149	Optional: - Pipe alu-galva Ø100/60 1000mm, painted anthracite For wet spaces/crawlspace (must not be continuously exposed to moisture) Including locking band and seals.	
	24150	Pipe alu-galva Ø100/60 500mm, adjustable (for dry spaces)	0.10 to 0.45
	24151	Optional: - Pipe alu-galva Ø100/60 500mm, painted anthracite For wet spaces/crawlspace (must not be continuously exposed to moisture) Including locking band and seals.	
	24152	Pipe alu-galva Ø100/60 325-440mm, telescopic Including locking band and seals.	0.28 to 0.38
Adaptors			
	24354	Adaptor alu-galva Ø200/130 to Ø100/60 Including locking band and seals. Required for an appliance with a flue spigot Ø200/130 with Power-Vent-02 [®] . Not available in SST.	0.11

	Item number DRU	Designation	Working length (m)
	24147	Adaptor alu-galva Ø150/100 to Ø100/60 Including locking band and seals. Required for an appliance with a flue spigot Ø150/100 with Power-Vent-02®. Not available in SST.	0.10
Bends			
	24153	Bend alu-galva Ø100/60 90°, smooth	-
	24154	Optional: - Bend alu-galva Ø100/60 90°, smooth, painted anthracite For wet spaces/crawlspace (must not be continuously exposed to moisture) Including locking band and seals.	
	24155	Bend alu-galva Ø100/60 45°, smooth, set of 2 pieces Including locking band and seals.	-
	24189	Bend alu-galva Ø100/60 30°, ribbed Including locking band and seals.	-
	24190	Bend alu-galva Ø100/60 15°, ribbed Including locking band and seals.	-
Through the roof (C31)			
	24440	PowerVent-02® fan unit, roof terminal, black grey Black grey powder coating RAL7021. Included: - Measuring unit (Venturi) with locking band and seals. *) Please see installation example 9 or 10 for further information	0.35 0.30
	24145	In- and outlet piece for PowerVent® for roof terminal	0.28
	24166	Adhesive plate for PowerVent-02® for roof terminal, for flat roof, H=400mm	-
	24156	Roof terminal alu-galva Ø100/60, BD300, black Adjustable to a working length of 0.64m Including locking band, silicone sealing ring, and mounting bracket.	0.57 to 1.19





	Item number DRU	Designation	Working length (m)
	24157	Roof terminal alu-galva Ø100/60, BD580, black Adjustable to a working length of 0.92m. Including locking band, silicone sealing ring, and mounting bracket.	0.83 to 1.19
	24159	Flat roof tile, 0°, aluminium, Ø350-Ø100	-
	24488	Universal tile, lead free, 15°- 60°, Ø100	-
Through the wall [C11]			
	24439	PowerVent-02® fan unit, wall terminal, black grey Black grey powder coating RAL7021. Included: - Measuring unit (Venturi) with locking band and seals.	0.10 0.30
	24158	Wall terminal alu-galva Ø100/60, black Black grey powder coating RAL7021. Adjustable to a working length of 0.10m (starting from the outside of the wall). Including locking band, silicone sealing ring, unpainted aluminium rosette 200x200mm. This can be used if the appearance of the PowerVent-02® fan unit for the outer wall is not acceptable. In this case, please use the following:	0.15 to 0.55
	24440	- PowerVent-02® fan unit, roof terminal	
	24167	- Mounting bracket for PowerVent-02® fan unit for roof terminal	
	24153	- Bend alu-galva Ø100/60 90°, smooth	
	24158	- Wall terminal alu-galva Ø100/60, black	
		Including locking band, silicone sealing ring, unpainted aluminium rosette 220x220mm, and 4 bolts 4.2x32	
	24163	Rosette aluminium Ø100, 220x220mm, anthracite	-
Through the chimney [C91]			
		The use of PowerVent-02® with an SST flex flue liner through the chimney is not permitted	
Wall and roof mounting			
	24197	Wall mounting bracket Ø100 The pipe system must be fixed in place every 2m.	-





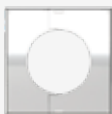

	Item number DRU	Designation	Working length (m)
	24167	Mounting bracket for PowerVent-02® fan unit for roof terminal	-
Condensation trap			
	24162	Condensation trap alu-galva Ø100/60, horizontal/vertical, Ø32 connection Including locking band and seals.	0.14
	24428	Waterless waist valve, horizontal/vertical, connection Ø32, complete set Can be installed both vertically and horizontally. For horizontal installation, the ribs must be positioned at the bottom.	-
Inspection and measurement			
	24164	T-piece alu-galva Ø100/60 L=260, for inspection purposes, with 2 sampling points Can be used either straight or as a 90° bend. Including locking band and seals.	0.20
	24165	Pipe alu-galva Ø100/60 L=165, with two measuring points Including locking band and seals.	0.12

PRODUCT RANGE: DRU LAS ES-E 200/150/100 INSULATED SYSTEM, SST GLOSS FOR OUTDOOR APPLICATIONS

Clearance to combustible building materials = 0cm

	Item number DRU	Designation Pipes straight and adjustable	Working length (m)
	24413	Pipe SST Ø200/150/100, insulated, 1000mm Not adjustable! Including locking band and seal.	0.95
	24414	Pipe SST Ø200/150/100, insulated, 500mm Not adjustable! Including locking band and seal.	0.45
	24424 24472	Pipe SST Ø200/150/100, insulated, 250mm Pipe SST Ø200/150/100, insulated, 320-450mm, telescopic Not adjustable! Including locking band and seals.	0.20 450
Connectors			
	24408	Adaptor SST from Ø150/100 to insulated system Ø200/150/100 Adaptor from LAS ES-I Ø150/100 to LAS ES-E 200/150/100 Including locking band and seal.	0.12
Bends, segmented			
	24415	Bend SST 45° Ø200/150/100, insulated, segmented Including locking band and seal.	-
	24416	Bend SST 30° Ø200/150/100, insulated, segmented Including locking band and seal.	-
Through the roof (C31)			
	24490 24427	Universal tile, lead free, 25°-55°, Ø200 Please note: Must be ordered with the following: - Storm collar SST Ø200	-
	24429 24427	Flat roof tile, 0°, aluminium unpainted, 625x625/Ø200 Please note: Must be ordered with the following: - Storm collar SST Ø200	-

	Item number DRU	Designation	Working length (m)
	24427	Storm collar SST Ø200	-
	24419	Roof terminal cap SST Ø200/150/100 Including locking band.	0.28
	24421	Flat roof-ceiling connection element SST Ø200/150/100, L=200, insulated Clearance to combustible materials is 0cm! Maximum bearing load of the wall and ceiling duct: 16m. For use as a flat roof duct Please note: For a flat roof duct, must be ordered with the following: - Flat roof tile, 0°, aluminium unpainted, 625x625/Ø200 - Storm collar SST Ø200 The system can be extended by the flat roof tile to a total height of 1.5m; anchoring may be necessary. For use as a ceiling duct Further construction can continue via the ceiling duct only using insulated pipes of LAS ES-E 200/150/100. Further construction with pipes from LAS ES-I 150/100 is not possible. Included: Locking band and seal. Not included: 4 bolts Ø8mm	0.20
	24429	- Flat roof tile, 0°, aluminium unpainted, 625x625/Ø200	-
	24427	- Storm collar SST Ø200	-
Through the wall (C11)			
	24409	Rosette SST Ø200, 330x330 Not included: 6 bolts Ø6mm	-
	24425	Wall terminal SST Ø200/150/100, telescopic 300-450mm, insulated Adjustable for wall thicknesses of 30cm to 45cm. Included: Locking band, seal, and SST rosette 280x280mm. Not included: 4 bolts Ø5mm	0.30 to 0.45

	Item number DRU	Designation	Working length (m)
Through the chimney (C91)			
		Not applicable	
Wall and roof mounting			
	24411 24473	<p>Wall support SST for Ø200/150/100, adjustable 130-180mm Extension for wall support SST for Ø200/150/100, adjustable 130-360mm</p> <p>- Adjustable to 30-80mm - The maximum bearing load of one support is 16m. For taller heights, the system must be braced by another supported.</p> <p>Including locking band and seals. Not included: 6 bolts Ø8</p>	-
	24420	<p>Wall mounting bracket SST Ø200, adjustable 130-180mm</p> <p>Adjustable to 30-80mm The pipe system must be fixed in place every 2m.</p>	-
	24417	<p>Roof support SST Ø200</p> <p>The system can be extended by the last support to a total height of 1.5m; anchoring may be necessary.</p> <p>Not included: 12 bolts Ø6mm</p>	-
Condensation trap			
	24412	<p>Condensation trap SST Ø200/150/100, insulated</p> <p>Including seal.</p>	0.14
Inspection and measurement, and T-pieces			
	24410	<p>T-piece SST Ø200/150/100, insulated</p> <p>For the transition from horizontal to vertical.</p> <p>Including locking band and seal.</p>	0.30
	24423	<p>T-piece SST Ø200/150/100, for inspection purposes, insulated</p> <p>Including locking band and seal.</p>	0.30

INSTALLATION EXAMPLE 1

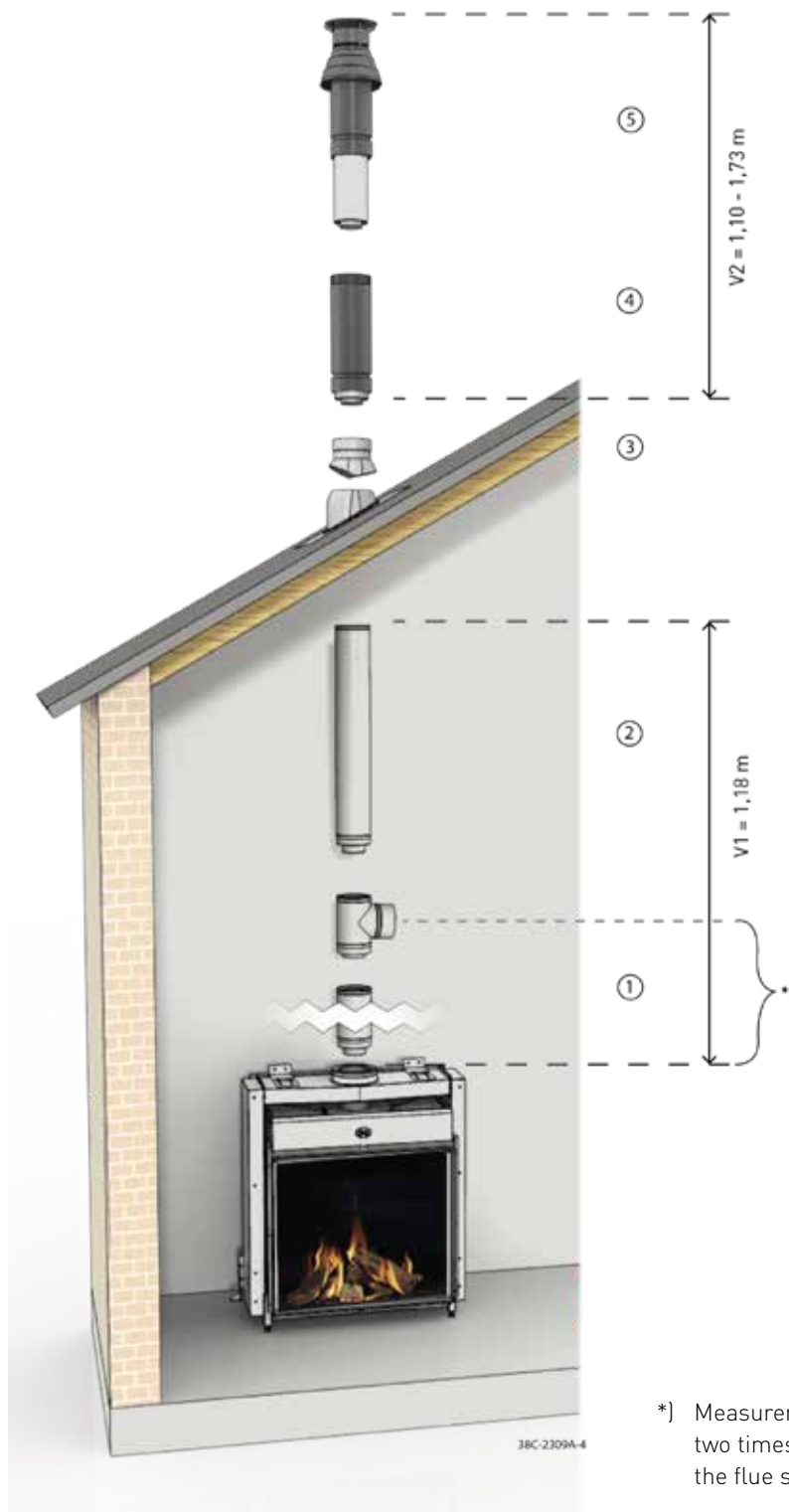

*) Measurement points at least two times the pipe diameter above the flue spigot

- The roof duct can be extended over the roof with one or more 'extensions over the roof', up to a total height of 1.50m beyond the last support, in compliance with country-specific regulations regarding the height over the roof; anchoring may be necessary.

- The measurement opening must be positioned approx. 2x D (2x pipe diameter) over the fireplace as per DIN 18160. To ensure trouble-free access, it is useful to position this at the height of the convection-air grille. The exact position of the inspection and measurement openings must be agreed upon in advance with the district chimney-sweep master (BSM).

DRU LAS ES-I 150/100, GLOSS SST VERTICAL THROUGH PITCHED ROOF (C31)

Through pitched roof of 25° to 45° (C31)			
Item	Parts	Item number	
		DRU	Working length (m)
1	- T-piece SST Ø150/100 L=270, for inspection, with 2 sampling points Also available in a painted option; please see LAS DRU ES-I 150/100	62859	0.23
2	- Pipe SST Ø150/100 1000mm Also available in a painted option; please see LAS DRU ES-I 150/100	24102	0.95
3	- Universal tile, lead free, 15°-60°, Ø150	24089	-
4	- Extension pipe SST Ø150/100 for roof terminal, L=500, black	24235	0.45
5	- Roof terminal SST, vertical, Ø150/100, black, BD300	24107	0.65 to 1.28
	Optional: - Roof terminal SST, vertical, Ø150/100, black, BD580	62862	0.93 to 1.28

- The chimney load must be absorbed by wall mounting brackets. These are recommended every 2m. The gas fireplace must not be subjected to static load. This must be ensured by other measures, if necessary, if brackets are not feasible.
- Roof duct without rear ventilation in the building; on-site fire protection measures may be necessary.

INSTALLATION EXAMPLE 2

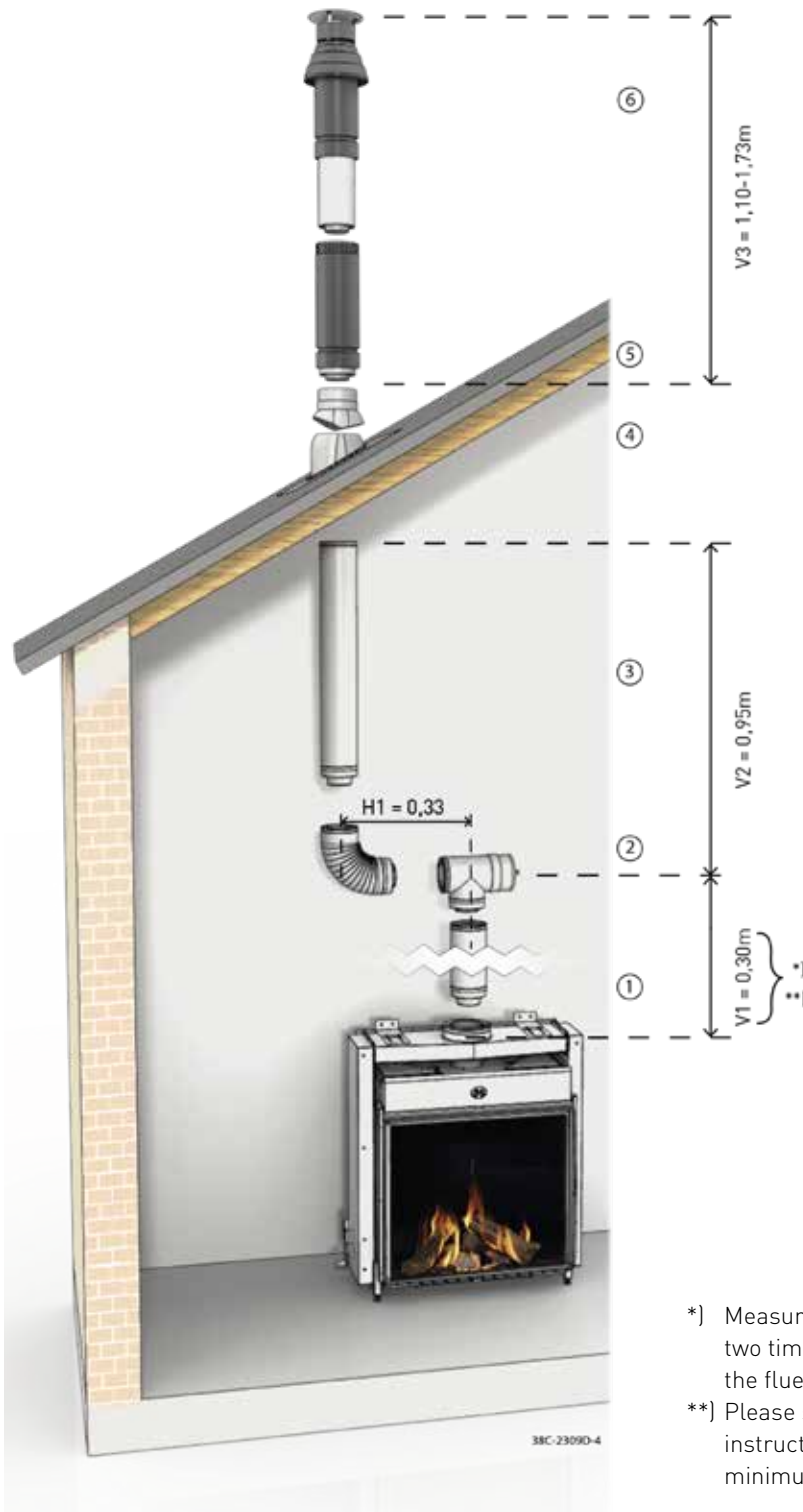

- *) Measurement points at least two times the pipe diameter above the flue spigot
- **) Please see the respective installation instructions for the appliance for the minimum approach distance

- The roof duct can be extended over the roof with one or more 'extensions over the roof', up to a total height of 1.50m beyond the last support, in compliance with country-specific regulations regarding the height over the roof; anchoring may be necessary.

- The measurement opening must be positioned approx. 2x D (2x pipe diameter) over the fireplace as per DIN 18160. To ensure trouble-free access, it is useful to position this at the height of the convection-air grille. The exact position of the inspection and measurement openings must be agreed upon in advance with the BSM.

DRU LAS ES-I 150/100, GLOSS SST WITH OFFSET THROUGH PITCHED ROOF (C31)

Through pitched roof of 25° to 45° (C31), with T-piece for inspection				
Item	Parts	Item number	Working length (m)	
		DRU	Vertical	Horizontal
1	- T-piece SST Ø150/100 L=270, for inspection, with 2 sampling points Also available in a painted option; please see LAS DRU ES-I 150/100 Can be used either straight or as a 90° bend. Including locking band and silicone sealing ring.	62859	0.11	0.11
2	- Bend SST 90° Ø150/100, ribbed	24105	0.19	0.22
3	- Pipe SST Ø150/100 1000mm Also available in a painted option; please see LAS DRU ES-I 150/100	24102	0.95	-
4	- Universal tile, lead free, 15°-60°, Ø150	24489	-	-
5	- Extension pipe SST Ø150/100 for roof terminal, L=500, black	24235	0.45	-
6	- Roof terminal SST, vertical, Ø150/100, black, BD300	24107	0.65 to 1.28	-
	Optional: - Roof terminal SST, vertical, Ø150/100, black, BD580	62862	0.93 to 1.28	-

- The chimney load must be absorbed by wall mounting brackets. These are recommended every 2m. The gas fireplace must not be subjected to static load. This must be ensured by other measures, if necessary, if brackets are not feasible.
- Roof duct without rear ventilation in the building; on-site fire protection measures may be necessary.

INSTALLATION EXAMPLE 3

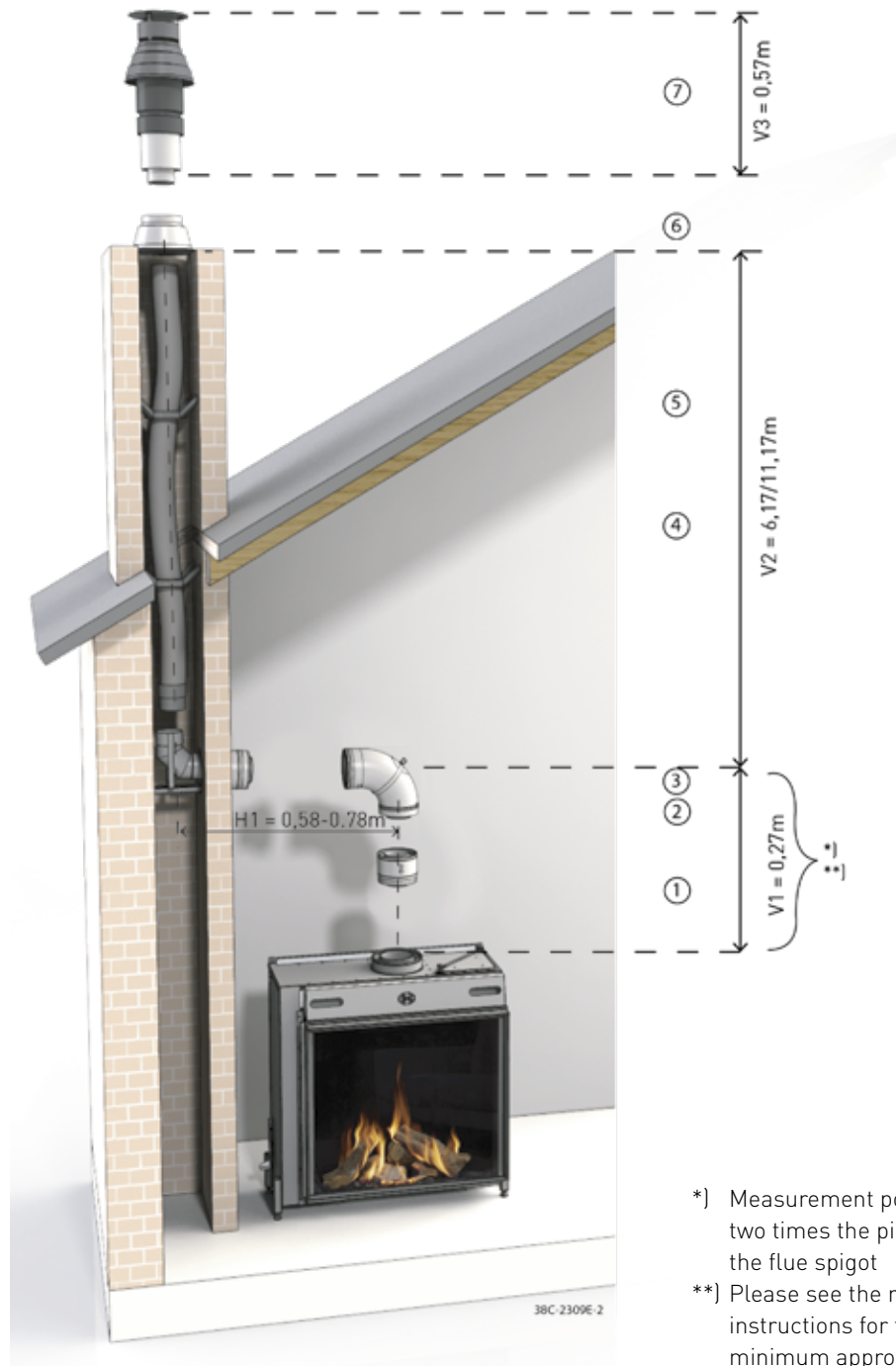

- The measurement opening must be positioned approx. $2 \times D$ ($2 \times$ pipe diameter) over the fireplace as per DIN 18160. To ensure trouble-free access, it is useful to position this at the height of the convection-air grille. The exact position must be coordinated in advance with the BSM.

- The chimney load must be absorbed by wall mounting brackets. These are recommended every 2m. The gas fireplace must not be subjected to static load. This must be ensured by other measures, if necessary, if brackets are not feasible.

DRU LAS ES-I 150/100, GLOSS SST WITH FLEX FLUE LINER THROUGH THE CHIMNEY (C91)

With flex flue liner through the chimney (C91), with a smooth inspection bend				
Item	Parts	Item number	Working length (m)	
		DRU	Vertical	Horizontal
1	- Pipe galva-SST Ø150/100 L=160, with two measuring points Also available in a painted option; please see LAS DRU ES-I 150/100	62860	0.11	-
2	- Inspection bend galva-SST Ø150/100 90° Also available in a painted option; please see LAS DRU ES-I 150/100	62861	0.16	0.23
3	- Chimney connection SST Ø150/100, with bend 90° Ø100	24195	0.17	0.35 to 0.55
4	- Flex flue liner SST Ø100, 6m, including adaptor SST Ø100, fixed/flex or flex/flex or - Flex flue liner SST Ø100, 11m, including adaptor SST Ø100, fixed/flex or flex/flex Adaptor: to connect two flexible pipes (or flexible pipes/exhaust pipes) to each other. Screw the connection elements on side 1: two studs on the SST flexible pipe, on side 2: Drill and screw SST flexible pipe.	24142	6.00	-
		24141	11.00	-
5	- Spacer for flexible SST pipe	24407	-	-
6	- Flat roof tile, 0°, aluminium, Ø430-Ø150	24031	-	-
7	- Chimney top SST Ø150/100, black Black powder coating RAL9005. or - Chimney top SST Ø150/100, unpainted	24108	0.57	-
		24406	0.57	-

- In section V2, in the chimney, a spacer must be installed every 3m.

INSTALLATION EXAMPLE 4

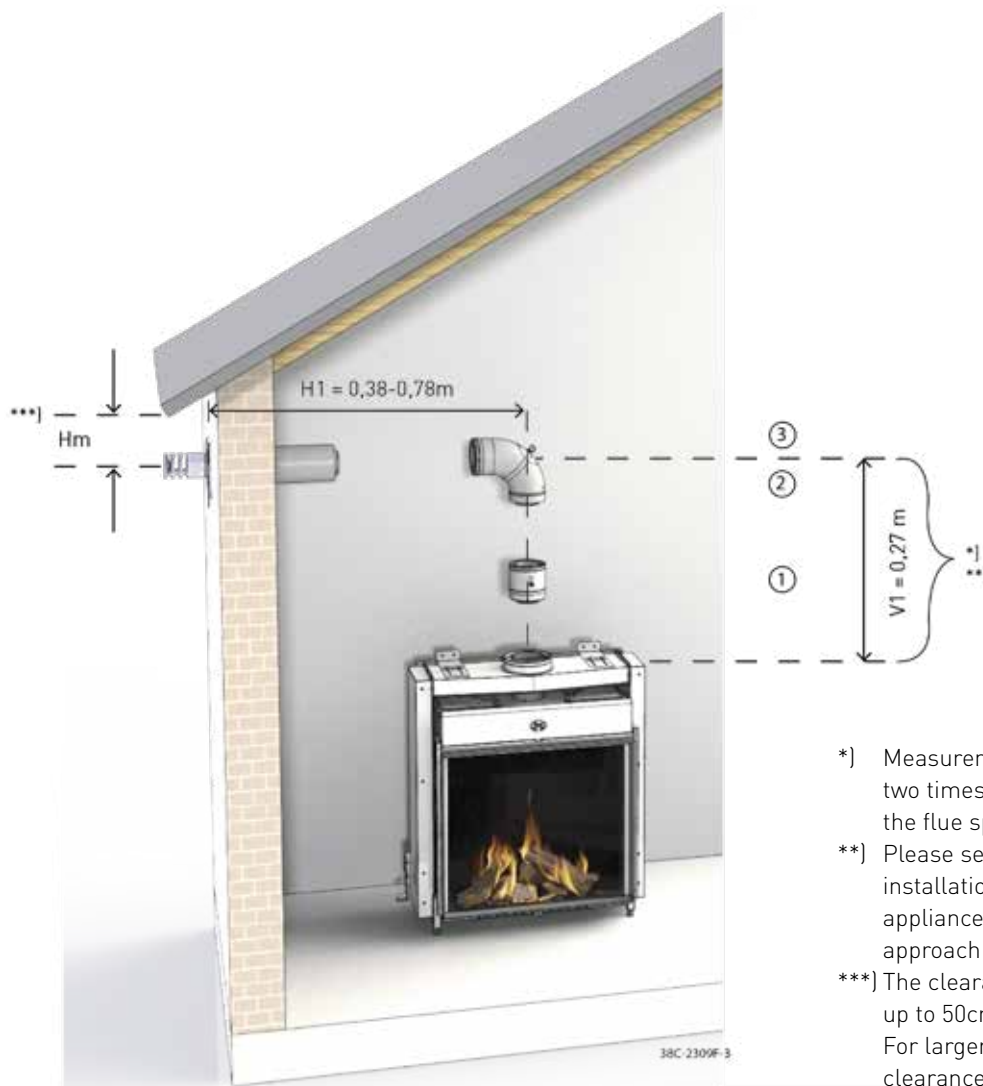

- *) Measurement points at least two times the pipe diameter above the flue spigot
- **) Please see the respective installation instructions for the appliance for the minimum approach distance
- ***) The clearance H_m to roof overhangs up to 50cm must be at least 50cm. For larger roof overhangs, this clearance must be increased proportionally.

- The measurement opening must be positioned approx. $2x D$ ($2x$ pipe diameter) over the fireplace as per DIN 18160. To ensure trouble-free access, it is useful to position this at the height of the convection-air grille. The exact position of the inspection and measurement openings must be agreed upon in advance with the BSM.

- The chimney load must be absorbed by wall mounting brackets. These are recommended every 2m. The gas fireplace must not be subjected to static load. This must be ensured by other measures, if necessary, if brackets are not feasible.

DRU LAS ES-I 150/100, GLOSS SST THROUGH THE WALL (C11)

Through the wall (C11), with inspection bend				
Item	Parts	Item number	Working length (m)	
		DRU	Vertical	Horizontal
1	- Pipe galva-SST Ø150/100 L=160, with two measuring points Also available in a painted option; please see LAS DRU ES-I 150/100	62860	0.11	-
2	- Inspection bend galva-SST Ø150/100 90° Also available in a painted option; please see LAS DRU ES-I 150/100 or	62861	0.16	0.23
	- Bend SST 90° Ø150/100, segmented, excentric (Bend with shortened branch length for a very shortened wall terminal, no inspection opening; discuss with BSM!)	24374	0.14	0.17
3	- Wall terminal SST Ø150/100, unpainted	24109	-	0.15 to 0.55

- The C11 design is generally subject to approval and must be agreed upon in advance with the appropriate BSM, because country-specific regulations must be complied with.

INSTALLATION EXAMPLE 5

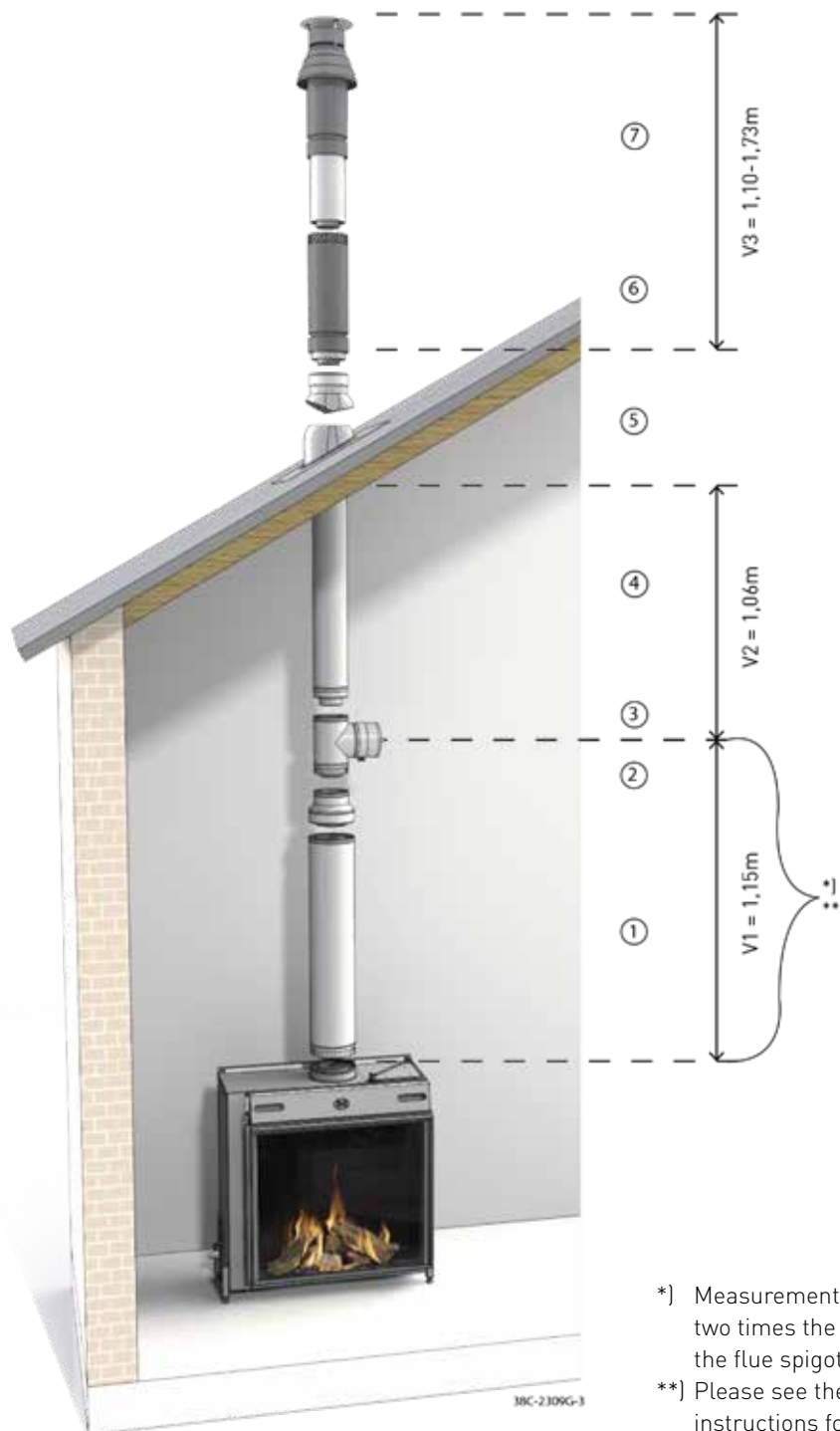

- *] Measurement points at least two times the pipe diameter above the flue spigot
- **] Please see the respective installation instructions for the appliance for the minimum approach distance

- The roof duct can be extended over the roof with one or more 'extensions over the roof', up to a total height of 1.50m beyond the last support, in compliance with country-specific regulations regarding the height over the roof; anchoring may be necessary.

- The measurement opening must be positioned approx. $2x D$ ($2x$ pipe diameter) over the fireplace as per DIN 18160. To ensure trouble-free access, it is useful to position this at the height of the convection-air grille. The exact position of the inspection and measurement openings must be agreed upon in advance with the BSM.

DRU LAS ES-I 200/130, GLOSS SST VERTICAL THROUGH PITCHED ROOF (C31)

Through pitched roof of 25° to 45° (C31)			
Item	Parts	Item number	Working length (m)
		DRU	
1	- Pipe SST Ø200/130 1000mm	62851	0.95
2	- Adaptor SST Ø200/130 to Ø150/100	62858	0.09
3	- T-piece SST Ø150/100 L=270, for inspection, with 2 sampling points	62859	0.23
4	- Pipe SST Ø150/100 1000mm	24102	0.95
5	- Universal tile, lead free, 15°-60°, Ø150	24489	-
6	- Extension pipe SST Ø150/100 for roof terminal, L=500, black	24235	0.45
6	- Roof terminal SST, vertical, Ø150/100, black, BD300	24107	0.65 to 1.28
	Optional: - Roof terminal SST, vertical, Ø150/100, black, BD580	62862	0.93 to 1.28

- The chimney load must be absorbed by wall mounting brackets. These are recommended every 2m. The gas fireplace must not be subjected to static load. This must be ensured by other measures, if necessary, if brackets are not feasible.
- Roof duct without rear ventilation in the building; on-site fire protection measures may be necessary.

INSTALLATION EXAMPLE 6

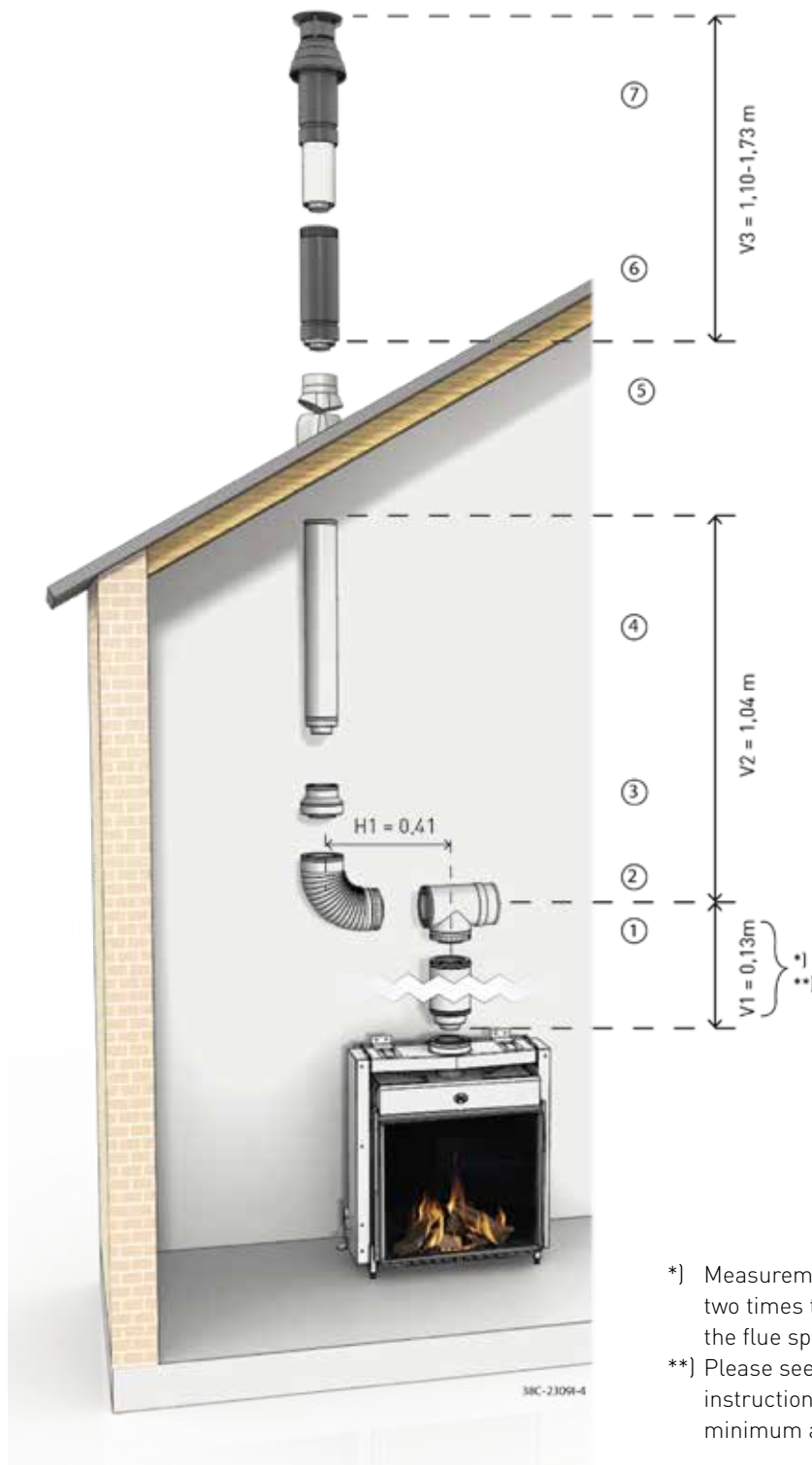

- *) Measurement points at least two times the pipe diameter above the flue spigot
- **) Please see the respective installation instructions for the appliance for the minimum approach distance

- The roof duct can be extended over the roof with one or more 'extensions over the roof', up to a total height of 1.50m beyond the last support, in compliance with country-specific regulations regarding the height over the roof; anchoring may be necessary.

- The measurement opening must be positioned approx. $2x D$ ($2x$ pipe diameter) over the fireplace as per DIN 18160. To ensure trouble-free access, it is useful to position this at the height of the convection-air grille. The exact position of the inspection and measurement openings must be agreed upon in advance with the BSM.

DRU LAS ES-I 200/130, GLOSS SST WITH OFFSET THROUGH PITCHED ROOF (C31)

Through pitched roof of 25° to 45° (C31), with T-piece for inspection				
Item	Parts	Item number	Working length (m)	
		DRU	Vertical	Horizontal
1	- T-piece SST Ø200/130 L=270, for inspection, with 2 sampling points	62856	0.13	0.14
2	- Bend SST 90° Ø200/130, ribbed	62853	0.24	0.28
3	- Adaptor SST Ø200/130 to Ø150/100	62858	0.09	-
4	- Pipe SST Ø150/100 1000mm	24102	0.95	-
5	- Universal tile, lead free, 15°-60°, Ø150	24489	-	-
6	- Extension pipe SST Ø150/100 for roof terminal, L=500, black	24235	0.45	-
7	- Roof terminal SST, vertical, Ø150/100, black, BD300	24107	0.65 to 1.28	-
	Optional: - Roof terminal SST, vertical, Ø150/100, black, BD580	62862	0.93 to 1.28	-

- The chimney load must be absorbed by wall mounting brackets. These are recommended every 2m. The gas fireplace must not be subjected to static load. This must be ensured by other measures, if necessary, if brackets are not feasible.
- Roof duct without rear ventilation in the building; on-site fire protection measures may be necessary.

INSTALLATION EXAMPLE 7

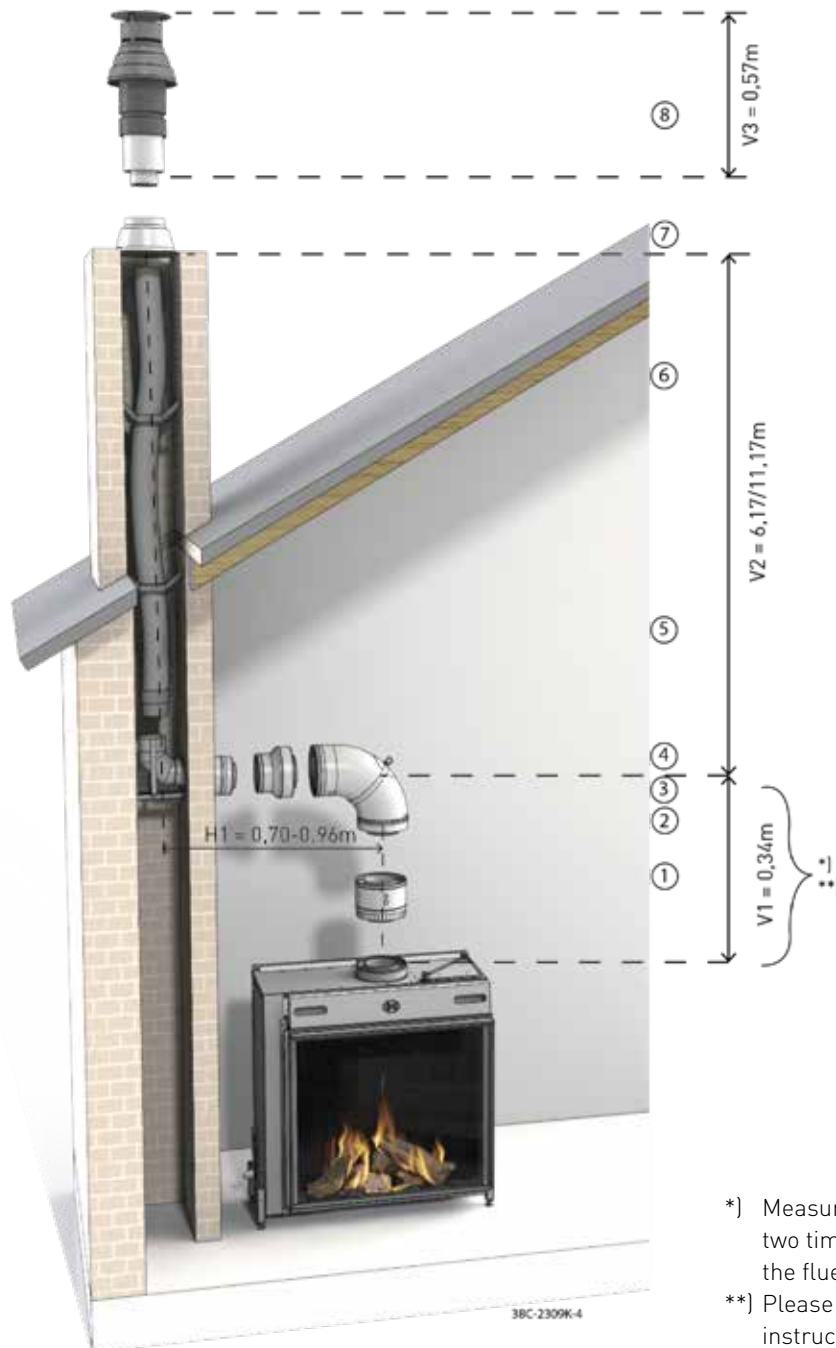

- *) Measurement points at least two times the pipe diameter above the flue spigot
- **) Please see the respective installation instructions for the appliance for the minimum approach distance

- The measurement opening must be positioned approx. $2 \times D$ ($2 \times$ pipe diameter) over the fireplace as per DIN 18160. To ensure trouble-free access, it is useful to position this at the height of the convection-air grille. The exact position must be coordinated in advance with the BSM.
- The chimney load must be absorbed by wall mounting brackets. These are recommended every 2m. The gas fireplace must not be subjected to static load. This must be ensured by other measures, if necessary, if brackets are not feasible.

DRU LAS ES-I 200/130, GLOSS SST WITH FLEX FLUE LINER THROUGH THE CHIMNEY (C91)

With flex flue liner through the chimney (C91), with a smooth inspection bend				
Item	Parts	Item number	Working length (m)	
		DRU	Vertical	Horizontal
1	- Pipe SST Ø200/130 L=160, with two measuring points	62857	0.12	-
2	- Inspection bend SST-galva Ø200/130 90°	24182	0.22	0.28
3	- Adaptor SST Ø200/130 to Ø150/100	62858	-	0.09
4	- Chimney connection SST Ø150/100, with bend 90° Ø100	24195	0.17	0.33 to 0.59
5	- Flex flue liner SST Ø100, 6m, including adaptor SST Ø100, fixed/flex or flex/flex or	24142	6.00	-
	- Flex flue liner SST Ø100, 11m, including adaptor SST Ø100, fixed/flex or flex/flex	24141	11.00	-
Adaptor: to connect two flexible pipes (or flexible pipes/exhaust pipes) to each other. Screw the connection elements on side 1: two studs on the SST flexible pipe, on side 2: Drill and screw SST flexible pipe.				
6	- Spacer for flexible SST pipe	24407	-	-
7	- Flat roof tile, 0°, aluminium, Ø430-Ø150	24031	-	-
8	- Chimney top SST Ø150/100, black Black powder coating RAL9005. or	24108	0.57	-
	- Chimney top SST Ø150/100, unpainted	24406	-	-

- In section V2, in the chimney, a spacer must be installed every 3m.

INSTALLATION EXAMPLE 8



- *) Measurement points at least two times the pipe diameter above the flue spigot
- **) Please see the respective installation instructions for the appliance for the minimum approach distance
- ***) The clearance Hm to roof overhangs up to 50cm must be at least 50cm. For larger roof overhangs, this clearance must be increased proportionally.

- The measurement opening must be positioned approx. $2x D$ ($2x$ pipe diameter) over the fireplace as per DIN 18160. To ensure trouble-free access, it is useful to position this at the height of the convection-air grille. The exact position of the inspection and measurement openings must be agreed upon in advance with the BSM.
- The chimney load must be absorbed by wall mounting brackets. These are recommended every 2m. The gas fireplace must not be subjected to static load. This must be ensured by other measures, if necessary, if brackets are not feasible.

DRU LAS ES-I 200/130, GLOSS SST THROUGH THE WALL (C11)

Through the wall (C11), with inspection bend				
Item	Parts	Item number	Working length (m)	
		DRU	Vertical	Horizontal
1	- Pipe SST Ø200/130 L=160, with two measuring points	62857	0.12	-
2	- Inspection bend SST-galva Ø200/130 90°	24182	0.22	0.28
3	- Pipe SST Ø200/130 1000mm	62851	-	0.95
4	- Wall terminal SST Ø200/130, unpainted	62855	-	0.15 to 0.55

- The C11 design is generally subject to approval and must be agreed upon in advance with the appropriate BSM, because country-specific regulations must be complied with.

INSTALLATION EXAMPLE 9

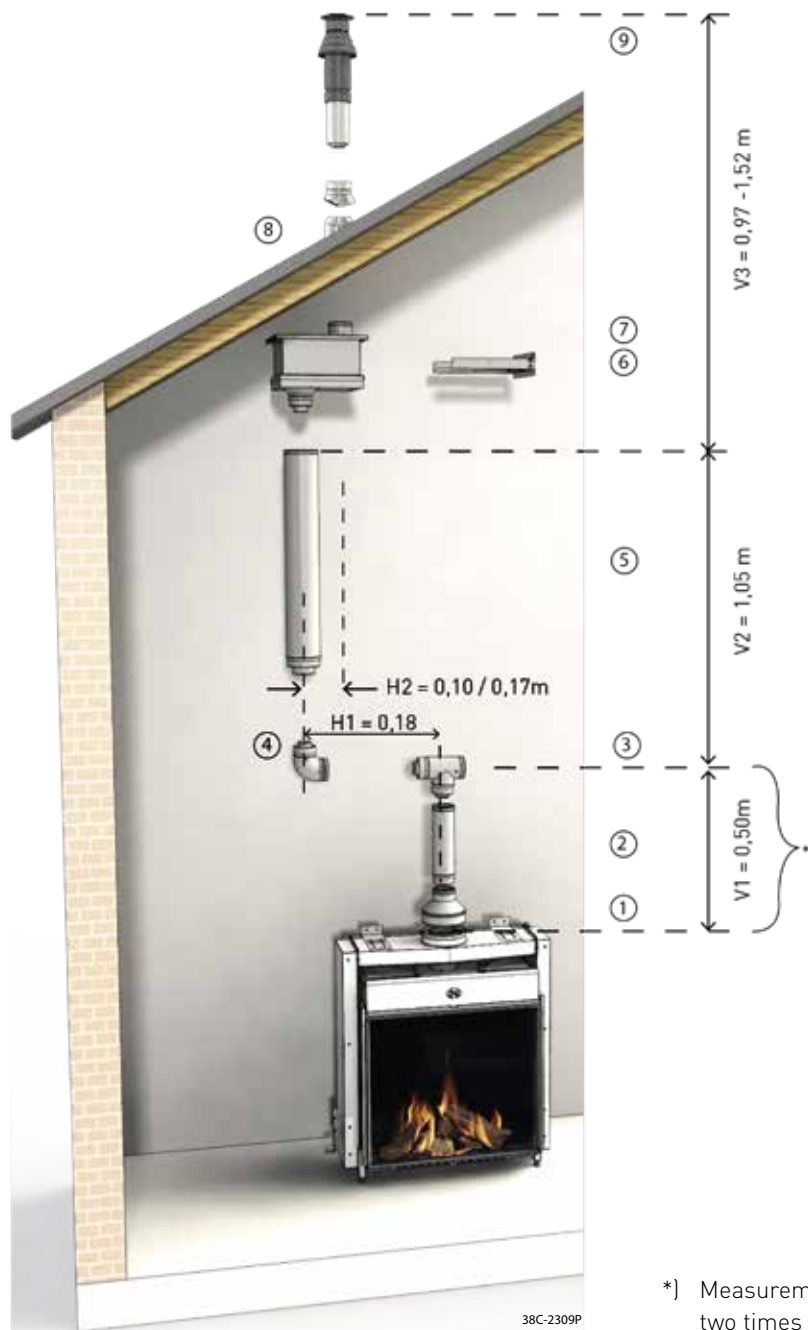

*] Measurement points at least two times the pipe diameter above the flue spigot

- The measurement opening must be positioned approx. $2 \times D$ ($2 \times$ pipe diameter) over the fireplace as per DIN 18160. To ensure trouble-free access, it is useful to position this at the height of the convection-air grille. The exact position must be coordinated in advance with the BSM.
- The chimney load must be absorbed by wall mounting brackets. These are recommended every 2m. The gas fireplace must not be subjected to static load. This must be ensured by other measures, if necessary, if brackets are not feasible.

DRU PV-I 100/60 POWERVENT-02® WITH OFFSET THROUGH PITCHED ROOF (C31), FAN UNIT BENEATH THE ROOF

Through pitched roof of 25° to 45° (C31), PowerVent-02® fan unit beneath the roof				
Item	Parts	Item number	Working length (m)	
		DRU	Vertical	Horizontal
1	- Adaptor alu-galva Ø200/130 to Ø100/60, for appliances with a flue spigot Ø200/130, or	24354	0.11	-
	- Adaptor alu-galva Ø150/100 to Ø100/60, for appliances with a flue spigot Ø150/100	24147	0.10	-
2	- Measuring unit (Venturi). Included in the PowerVent-02® fan unit scope of supply	n.a.	0.30	-
3	- T-piece alu-galva Ø100/60 L=260, for inspection purposes, with 2 sampling points	24164	0.09	0.09
4	- Bend alu-galva Ø100/60 90°, smooth	24153	0.10	0.09
5	- Pipe alu-galva Ø100/60 1000mm	24148	0.95	-
6	- Mounting bracket for PowerVent-02® fan unit for roof terminal	24167	-	-
7	- PowerVent-02® fan unit, roof terminal, black grey *) Please see drawing for 24440 at www.druservice.co.uk or www.druservice.com . Please note: PowerVent-02® can only be combined with DRU gas-fireplace inserts that have a Honeywell (RCH) control system. The PowerVent-02® control unit is installed in the appliance in its delivered condition and the parameters are tuned and preset on the appliance.	24440	0.35	0.14 *)
8	- Universal tile, lead free, 15°- 60°, Ø100	24489	-	-
9	- Roof terminal alu-galva Ø100/60, BD300, black	24156	0.57 to 1.19	-
	Optional - Roof terminal alu-galva Ø100/60, BD580, black	24157	0.83 to 1.19	-

- Roof duct without rear ventilation in the building; on-site fire protection measures may be necessary.
- Downstream of the PowerVent-02® fan unit, the maximum permissible pipe length to the terminal is 1m.
- The different minimum and maximum lengths for each gas appliance model must be adhered to. You can find these specifications in the installation instructions for the PowerVent-02®.

INSTALLATION EXAMPLE 10

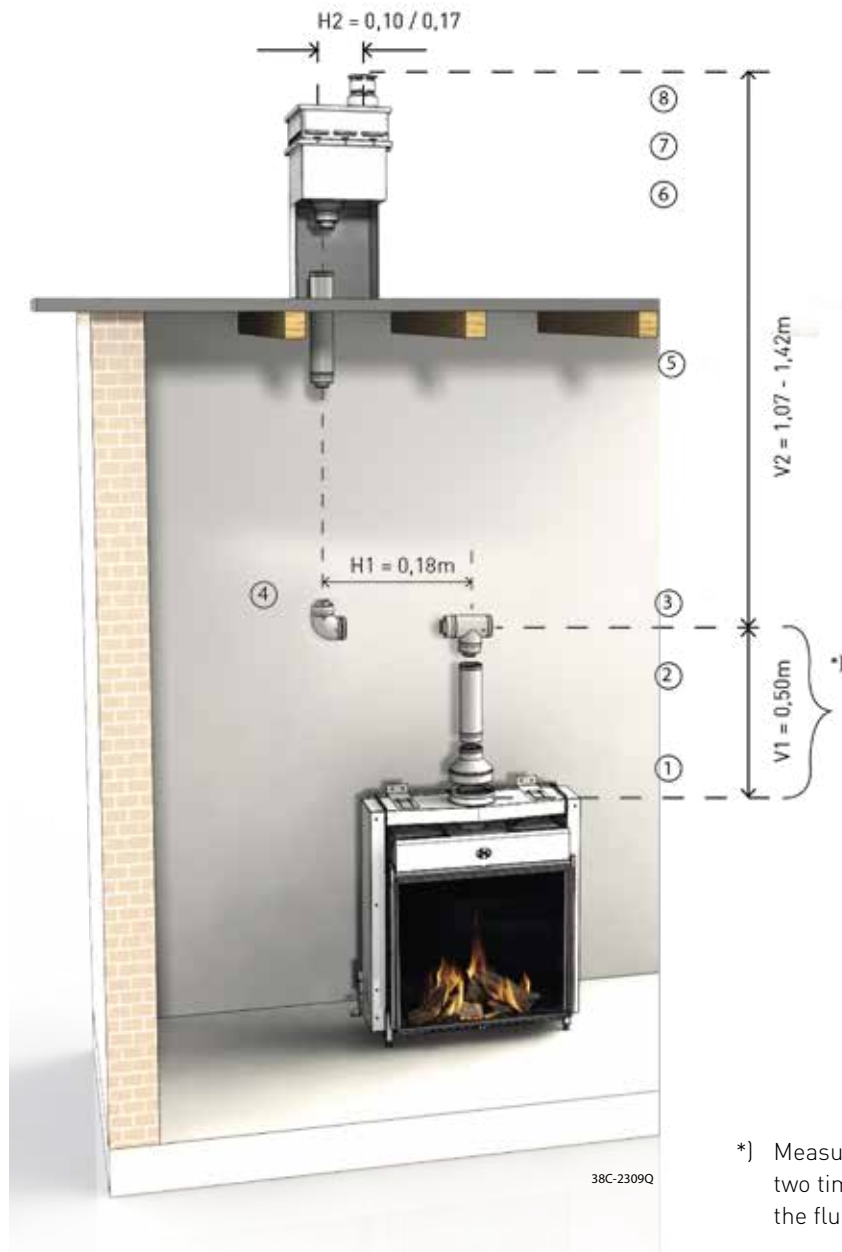

*) Measurement points at least two times the pipe diameter above the flue spigot

- The measurement opening must be positioned approx. $2x D$ ($2x$ pipe diameter) over the fireplace as per DIN 18160. To ensure trouble-free access, it is useful to position this at the height of the convection-air grille. The exact position must be coordinated in advance with the BSM.
- The chimney load must be absorbed by wall mounting brackets. These are recommended every 2m. The gas fireplace must not be subjected to static load. This must be ensured by other measures, if necessary, if brackets are not feasible.

DRU PV-I 100/60

POWERVENT-02[®] WITH OFFSET THROUGH FLAT ROOF (C31),
FAN UNIT ABOVE ON THE ROOF

Through flat roof (C31), PowerVent-02 [®] fan unit above on the flat roof				
Item	Parts	Item number	Working length (m)	
		DRU	Vertical	Horizontal
1	- Adaptor alu-galva Ø200/130 to Ø100/60, for appliances with a flue spigot Ø200/130,	24354	0.11	-
	or - Adaptor alu-galva Ø150/100 to Ø100/60, for appliances with a flue spigot Ø150/100	24147	0.10	-
2	- Measuring unit (Venturi). Included in the PowerVent-02 [®] fan unit scope of supply	n.a.	0.30	-
3	- T-piece alu-galva Ø100/60 L=260, for inspection purposes, with 2 sampling points	24164	0.09	0.09
4	- Bend alu-galva Ø100/60 90°, smooth	24153	0.10	0.09
5	- Pipe alu-galva Ø100/60 500mm, adjustable	1017711	0.10 to 0.45	-
6	- Adhesive plate for PowerVent-02 [®] for roof terminal, for flat roof, H=400mm *) The required pipe length from the bottom of the adhesive plate to the fan unit is 0.35m	24166	-*)	-
7	- PowerVent-02 [®] fan unit, roof terminal, black grey **) Please see drawing for 24440 at www.druservice.co.uk or www.druservice.com . Please note: PowerVent-02 [®] can only be combined with DRU gas-fireplace inserts that have a Honeywell (RCH) control system. The PowerVent-02 [®] control unit is installed in the appliance in its delivered condition and the parameters are tuned and preset on the appliance.	24440	0.35	0.14 **)
8	- In- and outlet piece for PowerVent [®] for roof terminal	24145	0.28	-

- Roof duct without rear ventilation in the building; on-site fire protection measures may be necessary.
- Downstream of the PowerVent-02[®] fan unit, the maximum permissible pipe length to the terminal is 1m.
- The different minimum and maximum lengths for each gas appliance model must be adhered to. You can find these specifications in the installation instructions for the PowerVent-02[®].

INSTALLATION EXAMPLE 11



- *] Measurement points at least two times the pipe diameter above the flue spigot
- **] Please see the respective installation instructions for the appliance for the minimum approach distance
- ***] The clearance Hm to roof overhangs up to 50cm must be at least 50cm. For larger roof overhangs, this clearance must be increased proportionally.

Through the wall (C11), with PowerVent-02® on the outer wall

Item	Parts	Item number	Working length (m)	
		DRU	Vertical	Horizontal
1	- Adaptor - Adaptor alu-galva Ø200/130 to Ø100/60, for appliances with a flue spigot Ø200/130, or - Adaptor alu-galva Ø150/100 to Ø100/60, for appliances with a flue spigot Ø150/100	24354	0.11	-
		24147	0.10	-
2	- T-piece alu-galva Ø100/60 L=260, for inspection purposes, with 2 sampling points	24164	0.09	0.09
3	- Measuring unit (Venturi). Included in the PowerVent-02® fan unit scope of supply	n.a.	-	0.30

- The measurement opening must be positioned approx. 2x D (2x pipe diameter) over the fireplace as per DIN 18160. To ensure trouble-free access, it is useful to position this at the height of the convection-air grille. The exact position must be coordinated in advance with the BSM.
- The chimney load must be absorbed by wall mounting brackets. These are recommended every 2m. The gas fireplace must not be subjected to static load. This must be ensured by other measures, if necessary, if brackets are not feasible.

DRU PV-I 100/60 POWERVENT-02® ON THE OUTER WALL, PIPES THROUGH CRAWLSPACE (C11)

Item	Parts	Item number	Working length (m)	
		DRU	Vertical	Horizontal
4	- Bend alu-galva Ø100/60 90°, smooth	24153	0.10	0.09
5	- Pipe alu-galva Ø100/60 1000mm	24148	0.95	-
6	- Bend alu-galva Ø100/60 90°, smooth, painted anthracite	24154	0.09	0.10
7	- Wall mounting bracket Ø100 The pipe system must be fixed in place every 2m	24197	-	-
8	- Condensation trap alu-galva Ø100/60, horizontal/vertical, Ø32 connection	24162	-	0.14
9	- Waterless waist valve, horizontal/vertical, connection Ø32, complete set	24428	-	-
10	- Pipe alu-galva Ø100/60 1000mm, painted anthracite	24149	-	0.95
11	- Bend alu-galva Ø100/60 90°, smooth, painted anthracite	24154	0.10	0.09
12	- Pipe alu-galva Ø100/60 325-440mm, telescopic Optional: - Pipe alu-galva Ø100/60 500mm, adjustable	24152 24150	0.28 to 0.38 0.10 to 0.45	- -
13	- Bend alu-galva Ø100/60 90°, smooth	24153	0.09	0.10
14	- Pipe alu-galva Ø100/60 500mm, adjustable	24150		0.10 to 0.45
15	- PowerVent-02® fan unit, wall terminal, black grey Please note: PowerVent-02® can only be combined with DRU gas-fireplace inserts that have a Honeywell (RCH) control system. The PowerVent-02® control unit is installed in the appliance in its delivered condition and the parameters are tuned and preset on the appliance.	24439	-0.09	-

- Downstream of the PowerVent-02® fan unit, the maximum permissible pipe length to the terminal is 1m.
- The different minimum and maximum lengths for each gas appliance model must be adhered to. You can find these specifications in the installation instructions for the PowerVent-02®.
- The C11 design is generally subject to approval and must be agreed upon in advance with the appropriate BSM, because country-specific regulations must be complied with.

INSTALLATION EXAMPLE 12

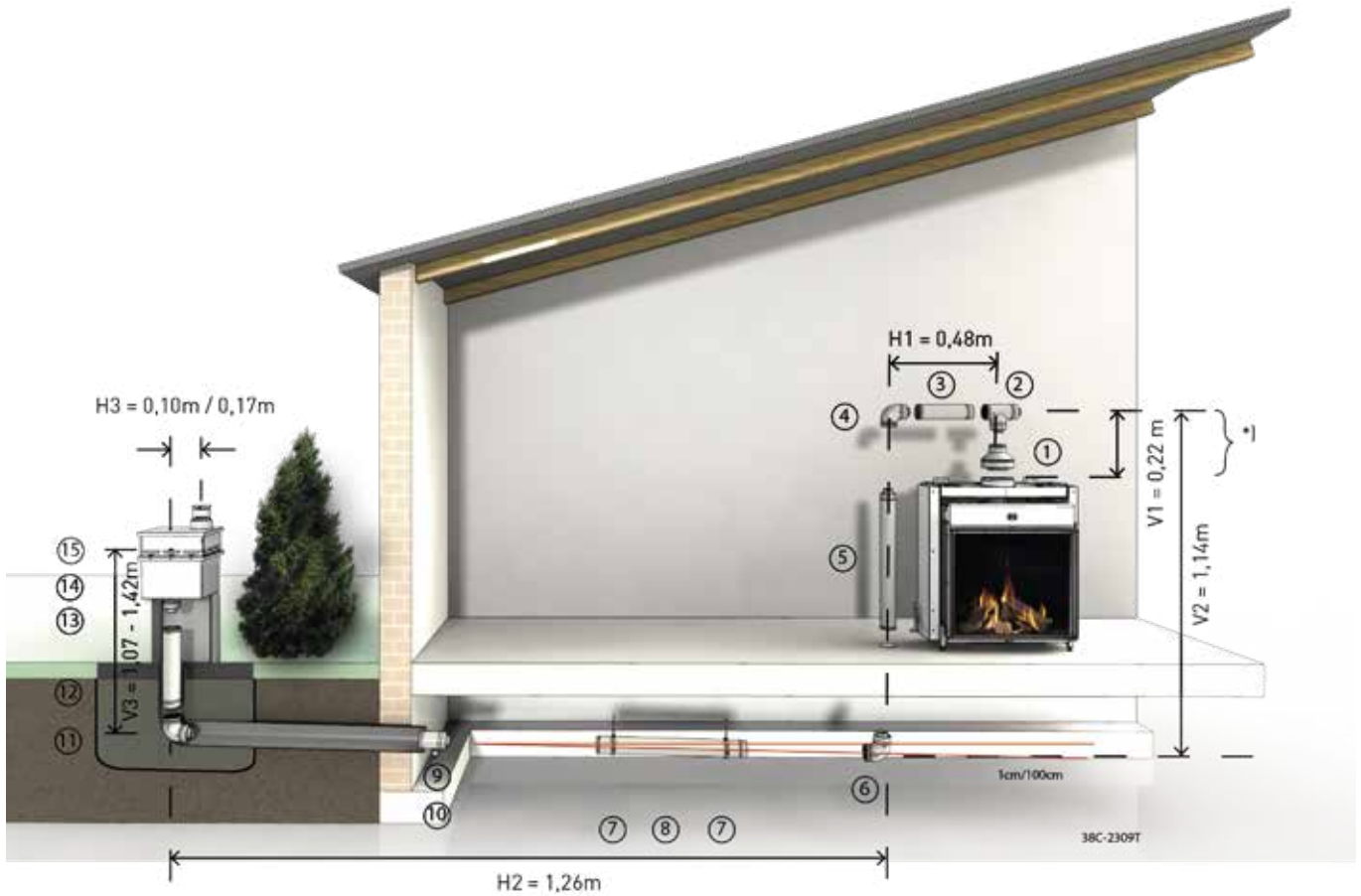

*) Measurement points at least two times the pipe diameter above the flue spigot

Through the wall (C11), with PowerVent-02® on the outer wall

Item	Parts	Item number	Working length (m)	
		DRU	Vertical	Horizontal
1	- Adaptor - Adaptor alu-galva Ø200/130 to Ø100/60, for appliances with a flue spigot Ø200/130, or - Adaptor alu-galva Ø150/100 to Ø100/60, for appliances with a flue spigot Ø150/100	24354 24147	0.13 0.10	- -
2	- T-piece alu-galva Ø100/60 L=260, for inspection purposes, with 2 sampling points	24164	0.09	0.09
3	- Measuring unit (Venturi). Included in the PowerVent-02® fan unit scope of supply	n.a.	-	0.30

- The measurement opening must be positioned approx. 2 D (2x pipe diameter) over the fireplace as per DIN 18160. To ensure trouble-free access, it is useful to position this at the height of the convection-air grille. The exact position must be coordinated in advance with the BSM.
- The chimney load must be absorbed by wall mounting brackets. These are recommended every 2m. The gas fireplace must not be subjected to static load. This must be ensured by other measures, if necessary, if brackets are not feasible.

DRU PV-I 100/60

POWERVENT-02® IN THE YARD, PIPES THROUGH CRAWLSPACE (C31)

Item	Parts	Item number	Working length (m)	
		DRU	Vertical	Horizontal
4	- Bend alu-galva Ø100/60 90°, smooth	24153	0.10	0.09
5	- Pipe alu-galva Ø100/60 1000mm	24148	0.95	-
6	- Bend alu-galva Ø100/60 90°, smooth, painted anthracite	24154	0.09	0.10
7	- Wall mounting bracket Ø100 The pipe system must be fixed in place every 2m	24197	-	-
8	- Pipe alu-galva Ø100/60 1000mm, painted anthracite	24149	-	0.95
9	- Condensation trap alu-galva Ø100/60, horizontal/vertical, Ø32 connection	24162	-	0.14
10	- Waterless waist valve, horizontal/vertical, connection Ø32, complete set	24428	-	-
11	- Bend alu-galva Ø100/60 90°, smooth, painted anthracite	24154	0.10	0.09
12	Pipe alu-galva Ø100/60 500mm, adjustable	24150	0.10 to 0.45	-
13	- Adhesive plate for PowerVent-02® for roof terminal, for flat roof, H=400mm *) The required pipe length from the bottom of the adhesive plate to the fan unit is 0.35m	24166	-*)	-
14	- PowerVent-02® fan unit, roof terminal, black grey **) Please see drawing for 24440 at www.druservice.co.uk or www.druservice.com . Please note: PowerVent-02® can only be combined with DRU gas-fireplace inserts that have a Honeywell (RCH) control system. The PowerVent-02® control unit is installed in the appliance in its delivered condition and the parameters are tuned and preset on the appliance.	24440	0.35	0.14 **)
15	In- and outlet piece for PowerVent® for roof terminal	24145	0.28	-

- The different minimum and maximum lengths for each gas appliance model must be adhered to. You can find these specifications in the installation instructions for the PowerVent-02®.
- If a discharge pipe is routed through the ground, it must be wrapped by a jacketed pipe that is continuously heat-resistant up to 200°C and watertight. The whole setup must be routed with a downward slope (1cm/m) toward the inside and a condensation trap must be installed, even if this is not specified in table 3. There must not be any points from which condensation cannot be drained off.

INSTALLATION EXAMPLE 13

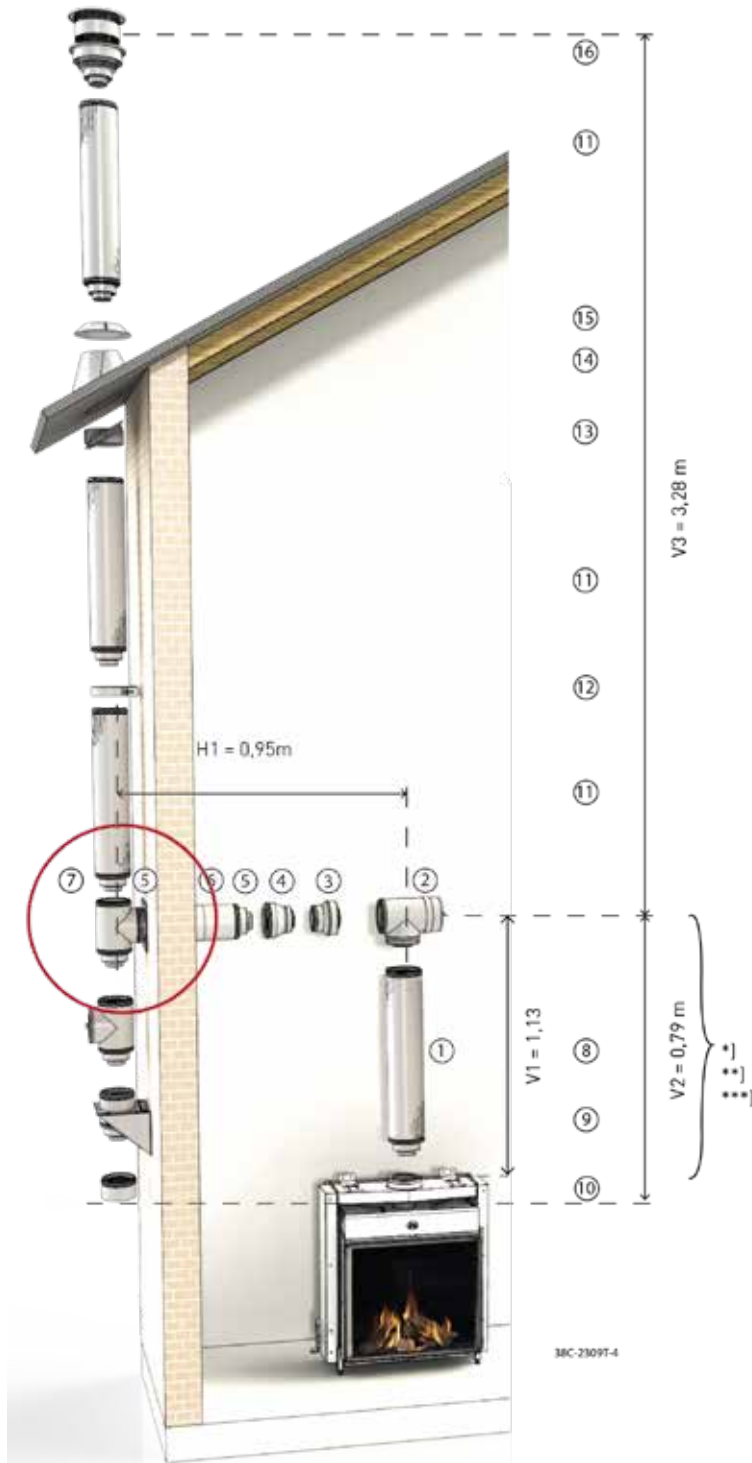

- *) Measurement points at least two times the pipe diameter above the flue spigot
- **) Please see the respective installation instructions for the appliance for the minimum approach distance
- ***) The maximum horizontal length of 200/150/100 is 50cm + adaptor. The maximum permissible horizontal length (please see installation instructions for the appliance) of Ø200/130 is 1.50m shorter in this case.

- The roof duct can be extended over the roof up to a total height of 1.50m beyond the last support; anchoring may be necessary. Height over the roof in compliance with country-specific regulations.

- The measurement opening must be positioned approx. 2D (2x pipe diameter) over the fireplace as per DIN 18160. To ensure trouble-free access, it is useful to position this at the height of the convection-air grille. The exact position of the inspection and measurement openings must be agreed upon in advance with the BSM.

DRU LAS ES-E 200/150/100, GLOSS SST VERTICALLY AT THE OUTER WALL THROUGH A ROOF OVERHANG (C31) FOR AN APPLIANCE WITH FLUE SPIGOT Ø200/130

Vertically along the outer wall through a roof overhang (C31) for an appliance with flue spigot Ø200/130				
Item	Parts	Item number	Working length (m)	
		DRU	Vertical	Horizontal
1	Minimum approach distance, e.g.: - 1.0m Pipe SST Ø200/130 1000mm	62851	0.95	-
2	- T-piece SST Ø200/130 L=270, for inspection, with 2 sampling points	62856	0.13	0.14
3	- Adaptor SST Ø200/130 to Ø150/100	62858	-	0.09
4	- Adaptor SST from Ø150/100 to insulated system Ø200/150/100	24408	-	0.12
5	- Rosette SST Ø200, 330x330 Please note: Order two sets, one for the inside and one for the outside.	24409	-	-
6	- Pipe SST Ø200/150/100, insulated, 500mm	24414	-	0.45
7	- T-piece SST Ø200/150/100, insulated	24410	0.30	0.15
8	- T-piece SST Ø200/150/100, for inspection purposes, insulated	24423	0.30	-
9	- Wall support SST for Ø200/150/100, adjustable 130-180mm	24411	0.20	-
10	- Condensation trap SST Ø200/150/100, insulated	24412	0.14	-
11	- Pipe SST Ø200/150/100, insulated, 1000mm Optional - Pipe SST Ø200/150/100, insulated, 500mm - Pipe SST Ø200/150/100, insulated, 250mm	24413 24414 24424	0.95 0.45 0.20	- - -
12	- Wall mounting bracket SST Ø200, adjustable 30-80mm	24420	-	-
13	- Roof support SST Ø200	24417	-	-
14	Universal tile, lead free, 25°-55°, Ø200 Please note: Must be ordered with the following: - Storm collar SST Ø200	24490 24427	- -	- -
15	- Storm collar SST Ø200	24427	-	-
16	- Roof terminal cap SST Ø200/150/100	24419	0.28	-

- The chimney load must be absorbed by a wall support (on the bottom of the system) and wall mounting brackets (every 2m). The gas fireplace must not be subjected to static load. This must be ensured by other measures, if necessary, if brackets are not feasible.
- Installation of locking bands in the masonry is permissible.
- Clearance to combustible building materials = 0cm.

INSTALLATION EXAMPLE 14

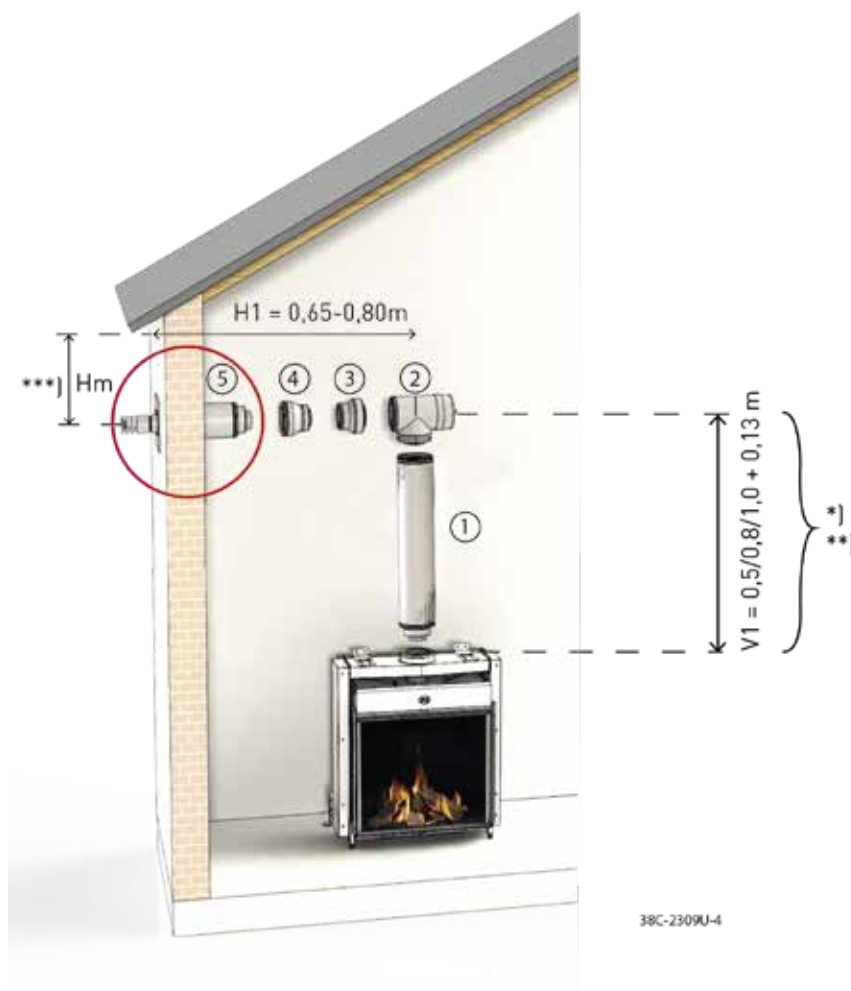

38C-2309U-4

- *) Measurement points at least two times the pipe diameter above the flue spigot
- ***) This example is not possible for every appliance with a flue spigot $\varnothing 200/130$. Please see the respective installation instructions for the appliance with regard to the following:
 - Minimum approach distance
 - Maximum permissible horizontal length from pipe $\varnothing 200/130$ or $\varnothing 200/150/100$
- ***) The clearance H_m to roof overhangs up to 50cm is always at least 50cm. For larger roof overhangs, this clearance must be increased proportionally.

- The measurement opening must be positioned approx. 2D (2x pipe diameter) over the fireplace as per DIN 18160. To ensure trouble-free access, it is useful to position this at the height of the convection-air grille. The exact position of the inspection and measurement openings must be agreed upon in advance with the BSM.
- The chimney load must be absorbed by wall mounting brackets. These are recommended every 2m. The gas fireplace must not be subjected to static load. This must be ensured by other measures, if necessary, if brackets are not feasible.

DRU LAS ES-E 200/150/100, GLOSS SST
 THROUGH THE WALL (C11)
 FOR AN APPLIANCE WITH FLUE SPIGOT Ø200/130

Through the wall (C31) for an appliance with flue spigot Ø200/130				
Item	Parts	Item number	Working length (m)	
		DRU	Vertical	Horizontal
1	Minimum approach distance (depending on appliance-specific and horizontal distances): - 0.5m Pipe SST Ø200/130 500mm, adjustable - 0.8m Pipe SST Ø200/130 500mm, adjustable (2x) - 1.0m Pipe SST Ø200/130 1000mm	62852	0.45	-
		62852	0.80	-
		62851	0.95	-
2	- T-piece SST Ø200/130 L=270, for inspection, with 2 sampling points	62856	0.13	0.14
3	- Adaptor SST Ø200/130 to Ø150/100	62858	-	0.09
4	- Adaptor SST from Ø150/100 to insulated system Ø200/150/100	24408	-	0.12
5	- Wall terminal SST Ø200/150/100, telescopic 300-450mm, insulated	24425	-	0.30 to 0.45

- The C11 design is must be agreed upon in advance with the appropriate BSM, because country-specific regulations must be complied with.
- Installation of locking bands in the masonry is permissible.
- Clearance to combustible building materials = 0cm.

INSTALLATION EXAMPLE 15

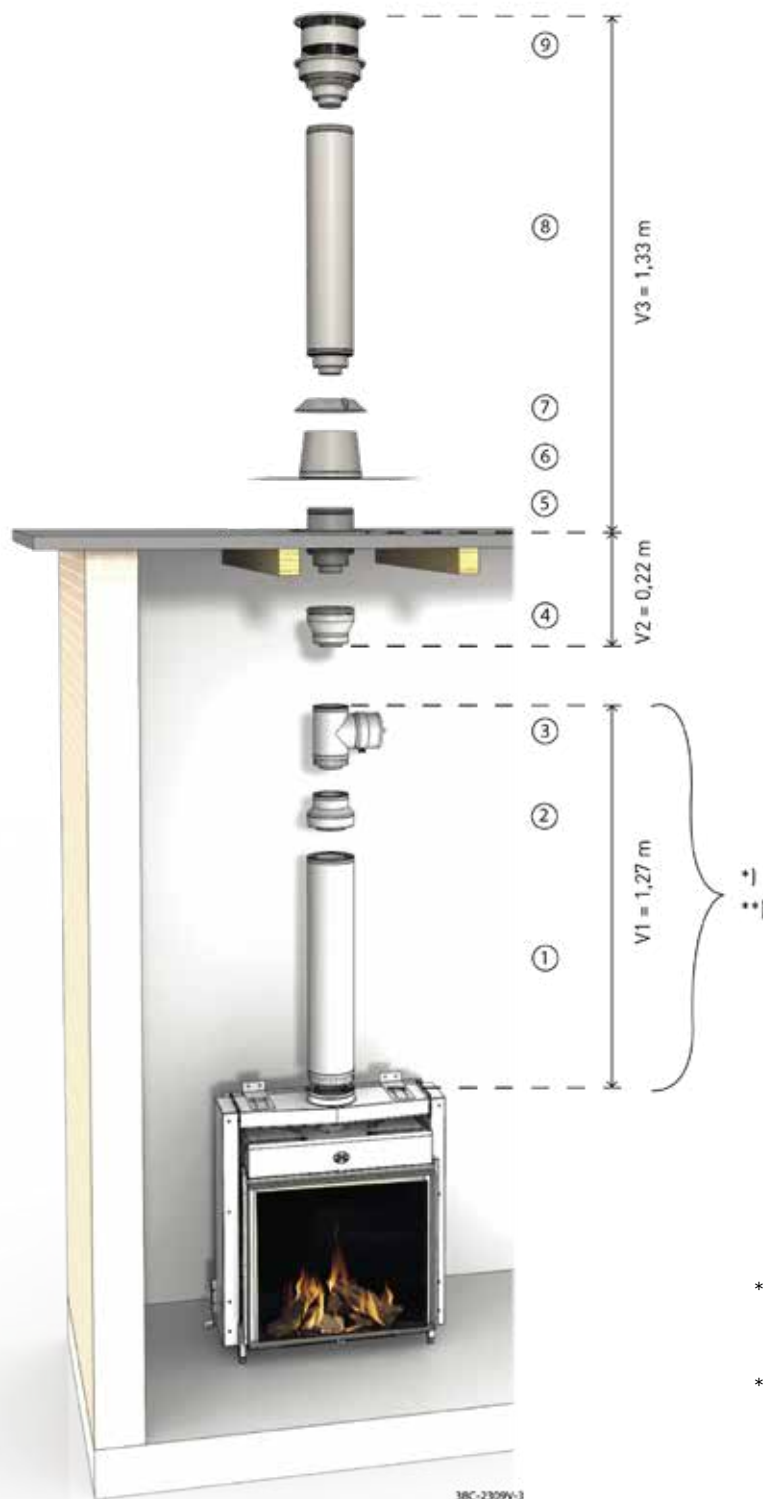

- *] Measurement points at least two times the pipe diameter above the flue spigot
- **] Please see the respective installation instructions for the appliance for the minimum approach distance

- The roof duct can be extended over the roof up to a total height of 1.50m beyond the last support; anchoring may be necessary. Height over the roof in compliance with country-specific regulations.
- The measurement opening must be positioned approx. 2D (2x pipe diameter) over the fireplace as per DIN 18160. To ensure trouble-free access, it is useful to position this at the height of the convection-air grille. The exact position of the inspection and measurement openings must be agreed upon in advance with the BSM.

DRU LAS ES-E 200/150/100, GLOSS SST VERTICAL THROUGH A FLAT ROOF WITH COMBUSTIBLE BUILDING MATERIALS (C31) FOR AN APPLIANCE WITH FLUE SPIGOT Ø200/130

Through a flat roof (C31) with combustible building materials for an appliance with flue spigot Ø200/130

Item	Parts	Item number	
		DRU	Working length (m)
1	- Pipe SST Ø200/130 1000mm	62851	0.95
2	- Adaptor SST Ø200/130 to Ø150/100	62858	0.09
3	- T-piece SST Ø150/100 L=270, for inspection, with 2 sampling points	62859	0.23
4	- Adaptor SST from Ø150/100 to insulated system Ø200/150/100	24408	0.12
5	- Flat roof-ceiling connection element SST Ø200/150/100, L=200, insulated	24421	0.20
	Please note: Must be ordered with the following:		
	- Flat roof tile, 0°, aluminium unpainted, 625x625	24429	-
	- Storm collar SST Ø200	24427	-
6	- Flat roof tile, 0°, aluminium unpainted, 625x625/Ø200	24429	-
7	- Storm collar SST Ø200	24427	-
8	- Pipe SST Ø200/150/100, insulated, 1000mm	24413	0.95
	Optional		
	- Pipe SST Ø200/150/100, insulated, 500mm	24414	0.45
	- Pipe SST Ø200/150/100, insulated, 250mm	24424	0.20
9	- Roof terminal cap SST Ø200/150/100	24419	0.28

- The chimney load must be absorbed by wall mounting brackets. These are recommended every 2m. The gas fireplace must not be subjected to static load. This must be ensured by other measures, if necessary, if brackets are not feasible.
- Clearance to combustible building materials = 0cm.

INSTALLATION EXAMPLE 16

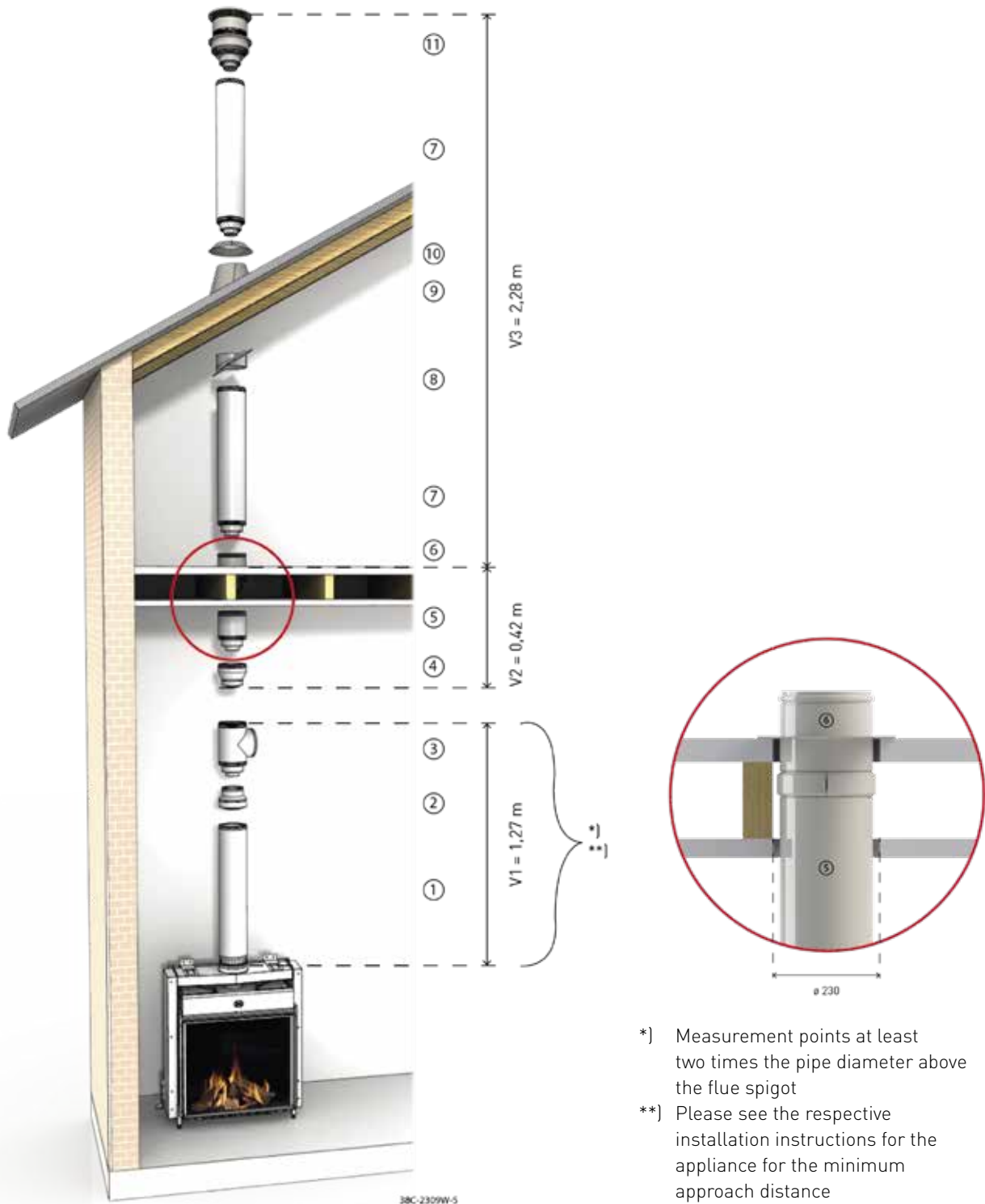

- *) Measurement points at least two times the pipe diameter above the flue spigot
- **) Please see the respective installation instructions for the appliance for the minimum approach distance

- The roof duct can be extended over the roof up to a total height of 1.50m beyond the last support; anchoring may be necessary. Height over the roof in compliance with country-specific regulations.

- The measurement opening must be positioned approx. 2D (2x pipe diameter) over the fireplace as per DIN 18160. To ensure trouble-free access, it is useful to position this at the height of the convection-air grille. The exact position of the inspection and measurement openings must be agreed upon in advance with the BSM.

DRU LAS ES-E 200/150/100, GLOSS SST VERTICAL THROUGH THE CEILING AND PITCHED ROOF (C31) FOR AN APPLIANCE WITH FLUE SPIGOT Ø200/130

Through the ceiling and pitched roof of 25° to 45° [C31] for an appliance with flue spigot Ø200/130

Item	Parts	Item number	
		DRU	Working length (m)
1	- Pipe SST Ø200/130 1000mm	62851	0.95
2	- Adaptor SST Ø200/130 to Ø150/100	62858	0.09
3	- T-piece SST Ø150/100 L=270, for inspection, with 2 sampling points	62859	0.23
4	- Adaptor SST from Ø150/100 to insulated system Ø200/150/100	24408	0.12
5	- Pipe SST Ø200/150/100, insulated, 250mm	24424	0.20
6	Flat roof-ceiling connection element SST Ø200/150/100, L=200, insulated	24421	0.20
7	- Pipe SST Ø200/150/100, insulated, 1000mm	24413	0.95
	Optional		
	- Pipe SST Ø200/150/100, insulated, 500mm	24414	0.45
	- Pipe SST Ø200/150/100, insulated, 250mm	24424	0.20
8	- Roof support SST Ø200	24417	-
9	- Universal tile, lead free, 25°-55°, Ø200	24490	-
	Please note: Must be ordered with the following:		
	- Storm collar SST Ø200	24427	-
10	- Storm collar SST Ø200	24427	-
11	- Roof terminal cap SST Ø200/150/100	24419	0.28

- The chimney load must be absorbed by wall mounting brackets. These are recommended every 2m. The gas fireplace must not be subjected to static load. This must be ensured by other measures, if necessary, if brackets are not feasible. The chimney load via the ceiling is absorbed by the wall and ceiling ducts.
- Clearance to combustible building materials = 0cm.

INSTALLATION INFORMATION

1

Mark the desired length of the outer pipe and cut the pipe sections

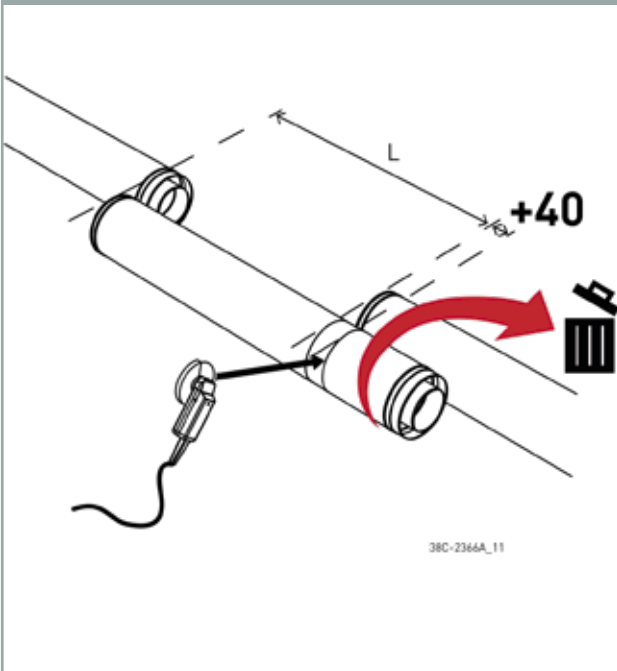

2

Mark the desired length of the inner pipe and cut the pipe sections

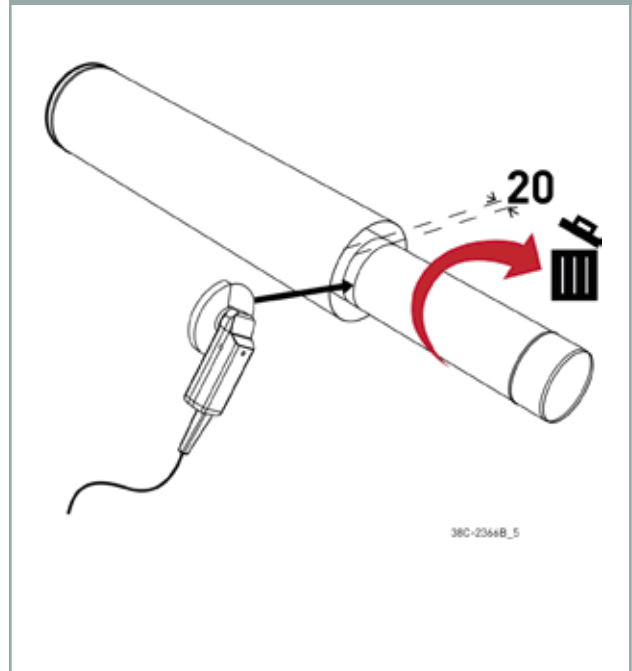

SHORTENING AN ADJUSTABLE PIPE

3

Remove burr from cut areas

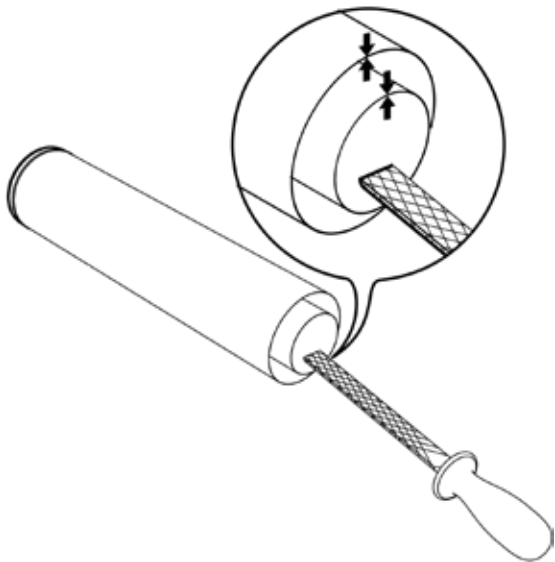

38C-2366C_6

4

If necessary: Make ribbing using crimping pliers

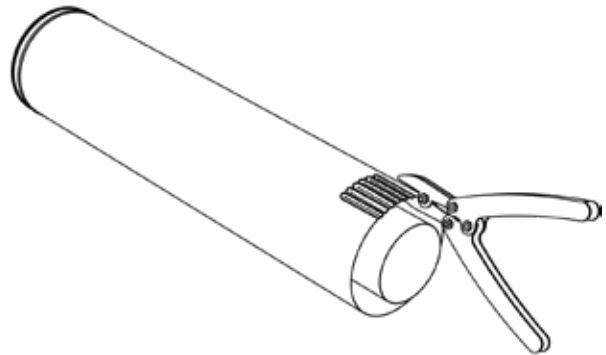

38C-2366D_1

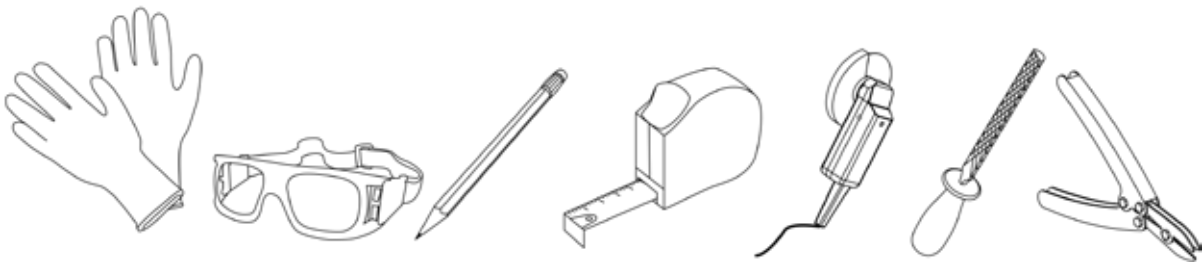

OFFSET TABLES 90°

DRU LAS ES-I 150/100, DRU LAS ES-I 200/130, DRU PV-I 100/60

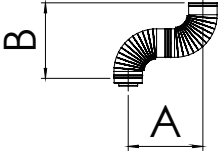
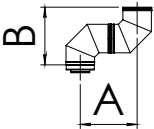
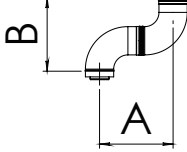
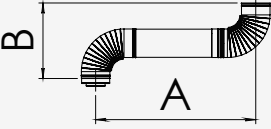
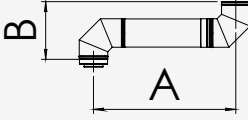
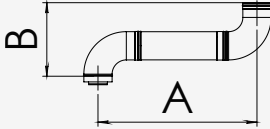
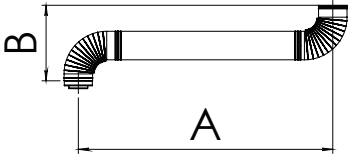
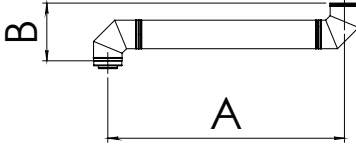
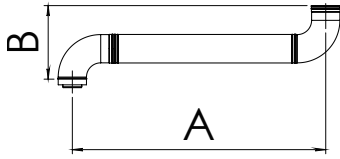
	ribbed bend	segmented bend	smooth bend																																													
0	 <table border="1"> <thead> <tr> <th></th> <th>A</th> <th>B</th> </tr> </thead> <tbody> <tr> <td>100/60</td> <td>-</td> <td>-</td> </tr> <tr> <td>150/100</td> <td>400</td> <td>400</td> </tr> <tr> <td>200/130</td> <td>505</td> <td>495</td> </tr> <tr> <td>200/150/100</td> <td>-</td> <td>-</td> </tr> </tbody> </table>		A	B	100/60	-	-	150/100	400	400	200/130	505	495	200/150/100	-	-	 <table border="1"> <thead> <tr> <th></th> <th>A</th> <th>B</th> </tr> </thead> <tbody> <tr> <td>100/60</td> <td>-</td> <td>-</td> </tr> <tr> <td>150/100</td> <td>300</td> <td>300</td> </tr> <tr> <td>200/130</td> <td>400</td> <td>400</td> </tr> <tr> <td>200/150/100</td> <td>-</td> <td>-</td> </tr> </tbody> </table>		A	B	100/60	-	-	150/100	300	300	200/130	400	400	200/150/100	-	-	 <table border="1"> <thead> <tr> <th></th> <th>A</th> <th>B</th> </tr> </thead> <tbody> <tr> <td>100/60</td> <td>170</td> <td>185</td> </tr> <tr> <td>150/100</td> <td>390</td> <td>390</td> </tr> <tr> <td>200/130</td> <td>-</td> <td>-</td> </tr> <tr> <td>200/150/100</td> <td>-</td> <td>-</td> </tr> </tbody> </table>		A	B	100/60	170	185	150/100	390	390	200/130	-	-	200/150/100	-	-
	A	B																																														
100/60	-	-																																														
150/100	400	400																																														
200/130	505	495																																														
200/150/100	-	-																																														
	A	B																																														
100/60	-	-																																														
150/100	300	300																																														
200/130	400	400																																														
200/150/100	-	-																																														
	A	B																																														
100/60	170	185																																														
150/100	390	390																																														
200/130	-	-																																														
200/150/100	-	-																																														
50 cm	 <table border="1"> <thead> <tr> <th></th> <th>A</th> <th>B</th> </tr> </thead> <tbody> <tr> <td>100/60</td> <td>-</td> <td>-</td> </tr> <tr> <td>150/100</td> <td>850</td> <td>400</td> </tr> <tr> <td>200/130</td> <td>955</td> <td>495</td> </tr> <tr> <td>200/150/100</td> <td>-</td> <td>-</td> </tr> </tbody> </table>		A	B	100/60	-	-	150/100	850	400	200/130	955	495	200/150/100	-	-	 <table border="1"> <thead> <tr> <th></th> <th>A</th> <th>B</th> </tr> </thead> <tbody> <tr> <td>100/60</td> <td>-</td> <td>-</td> </tr> <tr> <td>150/100</td> <td>750</td> <td>300</td> </tr> <tr> <td>200/130</td> <td>845</td> <td>405</td> </tr> <tr> <td>200/150/100</td> <td>-</td> <td>-</td> </tr> </tbody> </table>		A	B	100/60	-	-	150/100	750	300	200/130	845	405	200/150/100	-	-	 <table border="1"> <thead> <tr> <th></th> <th>A</th> <th>B</th> </tr> </thead> <tbody> <tr> <td>100/60</td> <td>630</td> <td>185</td> </tr> <tr> <td>150/100</td> <td>840</td> <td>390</td> </tr> <tr> <td>200/130</td> <td>-</td> <td>-</td> </tr> <tr> <td>200/150/100</td> <td>-</td> <td>-</td> </tr> </tbody> </table>		A	B	100/60	630	185	150/100	840	390	200/130	-	-	200/150/100	-	-
	A	B																																														
100/60	-	-																																														
150/100	850	400																																														
200/130	955	495																																														
200/150/100	-	-																																														
	A	B																																														
100/60	-	-																																														
150/100	750	300																																														
200/130	845	405																																														
200/150/100	-	-																																														
	A	B																																														
100/60	630	185																																														
150/100	840	390																																														
200/130	-	-																																														
200/150/100	-	-																																														
100 cm	 <table border="1"> <thead> <tr> <th></th> <th>A</th> <th>B</th> </tr> </thead> <tbody> <tr> <td>100/60</td> <td>-</td> <td>-</td> </tr> <tr> <td>150/100</td> <td>1350</td> <td>400</td> </tr> <tr> <td>200/130</td> <td>1445</td> <td>495</td> </tr> <tr> <td>200/150/100</td> <td>-</td> <td>-</td> </tr> </tbody> </table>		A	B	100/60	-	-	150/100	1350	400	200/130	1445	495	200/150/100	-	-	 <table border="1"> <thead> <tr> <th></th> <th>A</th> <th>B</th> </tr> </thead> <tbody> <tr> <td>100/60</td> <td>-</td> <td>-</td> </tr> <tr> <td>150/100</td> <td>1250</td> <td>300</td> </tr> <tr> <td>200/130</td> <td>1345</td> <td>405</td> </tr> <tr> <td>200/150/100</td> <td>-</td> <td>-</td> </tr> </tbody> </table>		A	B	100/60	-	-	150/100	1250	300	200/130	1345	405	200/150/100	-	-	 <table border="1"> <thead> <tr> <th></th> <th>A</th> <th>B</th> </tr> </thead> <tbody> <tr> <td>100/60</td> <td>1130</td> <td>185</td> </tr> <tr> <td>150/100</td> <td>1340</td> <td>390</td> </tr> <tr> <td>200/130</td> <td>-</td> <td>-</td> </tr> <tr> <td>200/150/100</td> <td>-</td> <td>-</td> </tr> </tbody> </table>		A	B	100/60	1130	185	150/100	1340	390	200/130	-	-	200/150/100	-	-
	A	B																																														
100/60	-	-																																														
150/100	1350	400																																														
200/130	1445	495																																														
200/150/100	-	-																																														
	A	B																																														
100/60	-	-																																														
150/100	1250	300																																														
200/130	1345	405																																														
200/150/100	-	-																																														
	A	B																																														
100/60	1130	185																																														
150/100	1340	390																																														
200/130	-	-																																														
200/150/100	-	-																																														

38C-2365A/0

OFFSET TABLES 45°

DRU LAS ES-I 150/100, DRU LAS ES-I 200/130, DRU PV-I 100/60

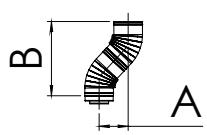
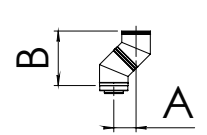
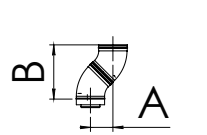
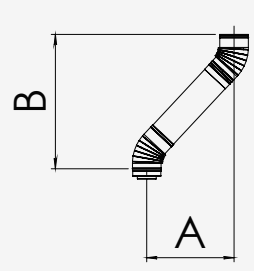
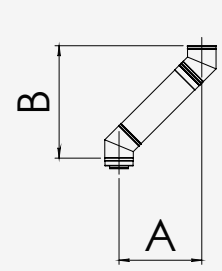
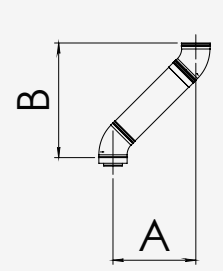
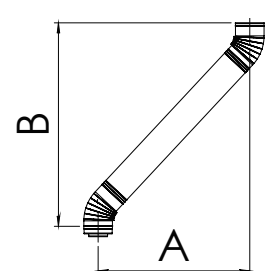
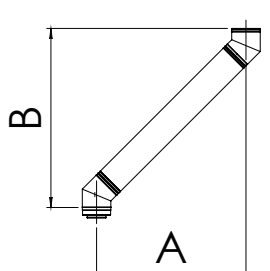
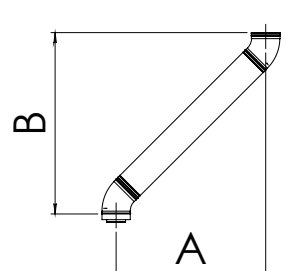
	ribbed bend	segmented bend	smooth bend																																													
0	 <table border="1"> <thead> <tr> <th></th> <th>A</th> <th>B</th> </tr> </thead> <tbody> <tr> <td>100/60</td> <td>-</td> <td>-</td> </tr> <tr> <td>150/100</td> <td>155</td> <td>390</td> </tr> <tr> <td>200/130</td> <td>190</td> <td>470</td> </tr> <tr> <td>200/150/100</td> <td>-</td> <td>-</td> </tr> </tbody> </table>		A	B	100/60	-	-	150/100	155	390	200/130	190	470	200/150/100	-	-	 <table border="1"> <thead> <tr> <th></th> <th>A</th> <th>B</th> </tr> </thead> <tbody> <tr> <td>100/60</td> <td>-</td> <td>-</td> </tr> <tr> <td>150/100</td> <td>120</td> <td>285</td> </tr> <tr> <td>200/130</td> <td>195</td> <td>480</td> </tr> <tr> <td>200/150/100</td> <td>170</td> <td>425</td> </tr> </tbody> </table>		A	B	100/60	-	-	150/100	120	285	200/130	195	480	200/150/100	170	425	 <table border="1"> <thead> <tr> <th></th> <th>A</th> <th>B</th> </tr> </thead> <tbody> <tr> <td>100/60</td> <td>70</td> <td>200</td> </tr> <tr> <td>150/100</td> <td>120</td> <td>285</td> </tr> <tr> <td>200/130</td> <td>-</td> <td>-</td> </tr> <tr> <td>200/150/100</td> <td>-</td> <td>-</td> </tr> </tbody> </table>		A	B	100/60	70	200	150/100	120	285	200/130	-	-	200/150/100	-	-
	A	B																																														
100/60	-	-																																														
150/100	155	390																																														
200/130	190	470																																														
200/150/100	-	-																																														
	A	B																																														
100/60	-	-																																														
150/100	120	285																																														
200/130	195	480																																														
200/150/100	170	425																																														
	A	B																																														
100/60	70	200																																														
150/100	120	285																																														
200/130	-	-																																														
200/150/100	-	-																																														
50 cm	 <table border="1"> <thead> <tr> <th></th> <th>A</th> <th>B</th> </tr> </thead> <tbody> <tr> <td>100/60</td> <td>-</td> <td>-</td> </tr> <tr> <td>150/100</td> <td>475</td> <td>710</td> </tr> <tr> <td>200/130</td> <td>495</td> <td>495</td> </tr> <tr> <td>200/150/100</td> <td>-</td> <td>-</td> </tr> </tbody> </table>		A	B	100/60	-	-	150/100	475	710	200/130	495	495	200/150/100	-	-	 <table border="1"> <thead> <tr> <th></th> <th>A</th> <th>B</th> </tr> </thead> <tbody> <tr> <td>100/60</td> <td>-</td> <td>-</td> </tr> <tr> <td>150/100</td> <td>435</td> <td>605</td> </tr> <tr> <td>200/130</td> <td>515</td> <td>785</td> </tr> <tr> <td>200/150/100</td> <td>490</td> <td>745</td> </tr> </tbody> </table>		A	B	100/60	-	-	150/100	435	605	200/130	515	785	200/150/100	490	745	 <table border="1"> <thead> <tr> <th></th> <th>A</th> <th>B</th> </tr> </thead> <tbody> <tr> <td>100/60</td> <td>370</td> <td>490</td> </tr> <tr> <td>150/100</td> <td>440</td> <td>605</td> </tr> <tr> <td>200/130</td> <td>-</td> <td>-</td> </tr> <tr> <td>200/150/100</td> <td>-</td> <td>-</td> </tr> </tbody> </table>		A	B	100/60	370	490	150/100	440	605	200/130	-	-	200/150/100	-	-
	A	B																																														
100/60	-	-																																														
150/100	475	710																																														
200/130	495	495																																														
200/150/100	-	-																																														
	A	B																																														
100/60	-	-																																														
150/100	435	605																																														
200/130	515	785																																														
200/150/100	490	745																																														
	A	B																																														
100/60	370	490																																														
150/100	440	605																																														
200/130	-	-																																														
200/150/100	-	-																																														
100 cm	 <table border="1"> <thead> <tr> <th></th> <th>A</th> <th>B</th> </tr> </thead> <tbody> <tr> <td>100/60</td> <td>-</td> <td>-</td> </tr> <tr> <td>150/100</td> <td>825</td> <td>1060</td> </tr> <tr> <td>200/130</td> <td>835</td> <td>1160</td> </tr> <tr> <td>200/150/100</td> <td>-</td> <td>-</td> </tr> </tbody> </table>		A	B	100/60	-	-	150/100	825	1060	200/130	835	1160	200/150/100	-	-	 <table border="1"> <thead> <tr> <th></th> <th>A</th> <th>B</th> </tr> </thead> <tbody> <tr> <td>100/60</td> <td>-</td> <td>-</td> </tr> <tr> <td>150/100</td> <td>785</td> <td>955</td> </tr> <tr> <td>200/130</td> <td>865</td> <td>1135</td> </tr> <tr> <td>200/150/100</td> <td>840</td> <td>1100</td> </tr> </tbody> </table>		A	B	100/60	-	-	150/100	785	955	200/130	865	1135	200/150/100	840	1100	 <table border="1"> <thead> <tr> <th></th> <th>A</th> <th>B</th> </tr> </thead> <tbody> <tr> <td>100/60</td> <td>715</td> <td>955</td> </tr> <tr> <td>150/100</td> <td>790</td> <td>960</td> </tr> <tr> <td>200/130</td> <td>-</td> <td>-</td> </tr> <tr> <td>200/150/100</td> <td>-</td> <td>-</td> </tr> </tbody> </table>		A	B	100/60	715	955	150/100	790	960	200/130	-	-	200/150/100	-	-
	A	B																																														
100/60	-	-																																														
150/100	825	1060																																														
200/130	835	1160																																														
200/150/100	-	-																																														
	A	B																																														
100/60	-	-																																														
150/100	785	955																																														
200/130	865	1135																																														
200/150/100	840	1100																																														
	A	B																																														
100/60	715	955																																														
150/100	790	960																																														
200/130	-	-																																														
200/150/100	-	-																																														

38C-2365B/0

OFFSET TABLES 30°

DRU LAS ES-I 150/100, DRU LAS ES-I 200/130, DRU PV-I 100/60

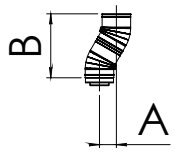
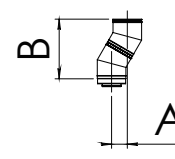
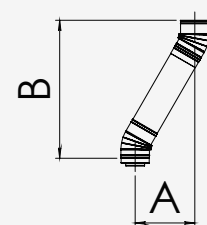
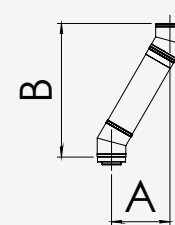
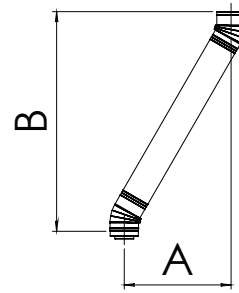
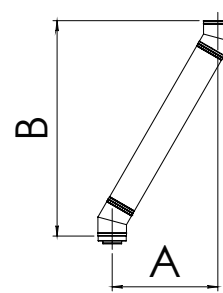
	ribbed bend	segmented bend	smooth bend																														
0	 <table border="1"> <thead> <tr> <th></th> <th>A</th> <th>B</th> </tr> </thead> <tbody> <tr> <td>100/60</td> <td>85</td> <td>320</td> </tr> <tr> <td>150/100</td> <td>90</td> <td>335</td> </tr> <tr> <td>200/130</td> <td>110</td> <td>410</td> </tr> <tr> <td>200/150/100</td> <td>-</td> <td>-</td> </tr> </tbody> </table>		A	B	100/60	85	320	150/100	90	335	200/130	110	410	200/150/100	-	-	 <table border="1"> <thead> <tr> <th></th> <th>A</th> <th>B</th> </tr> </thead> <tbody> <tr> <td>100/60</td> <td>-</td> <td>-</td> </tr> <tr> <td>150/100</td> <td>85</td> <td>310</td> </tr> <tr> <td>200/130</td> <td>110</td> <td>415</td> </tr> <tr> <td>200/150/100</td> <td>110</td> <td>420</td> </tr> </tbody> </table>		A	B	100/60	-	-	150/100	85	310	200/130	110	415	200/150/100	110	420	not available
	A	B																															
100/60	85	320																															
150/100	90	335																															
200/130	110	410																															
200/150/100	-	-																															
	A	B																															
100/60	-	-																															
150/100	85	310																															
200/130	110	415																															
200/150/100	110	420																															
50 cm	 <table border="1"> <thead> <tr> <th></th> <th>A</th> <th>B</th> </tr> </thead> <tbody> <tr> <td>100/60</td> <td>310</td> <td>710</td> </tr> <tr> <td>150/100</td> <td>315</td> <td>725</td> </tr> <tr> <td>200/130</td> <td>335</td> <td>800</td> </tr> <tr> <td>200/150/100</td> <td>-</td> <td>-</td> </tr> </tbody> </table>		A	B	100/60	310	710	150/100	315	725	200/130	335	800	200/150/100	-	-	 <table border="1"> <thead> <tr> <th></th> <th>A</th> <th>B</th> </tr> </thead> <tbody> <tr> <td>100/60</td> <td>-</td> <td>-</td> </tr> <tr> <td>150/100</td> <td>310</td> <td>700</td> </tr> <tr> <td>200/130</td> <td>335</td> <td>800</td> </tr> <tr> <td>200/150/100</td> <td>335</td> <td>810</td> </tr> </tbody> </table>		A	B	100/60	-	-	150/100	310	700	200/130	335	800	200/150/100	335	810	not available
	A	B																															
100/60	310	710																															
150/100	315	725																															
200/130	335	800																															
200/150/100	-	-																															
	A	B																															
100/60	-	-																															
150/100	310	700																															
200/130	335	800																															
200/150/100	335	810																															
100 cm	 <table border="1"> <thead> <tr> <th></th> <th>A</th> <th>B</th> </tr> </thead> <tbody> <tr> <td>100/60</td> <td>560</td> <td>1145</td> </tr> <tr> <td>150/100</td> <td>565</td> <td>1160</td> </tr> <tr> <td>200/130</td> <td>580</td> <td>1230</td> </tr> <tr> <td>200/150/100</td> <td>-</td> <td>-</td> </tr> </tbody> </table>		A	B	100/60	560	1145	150/100	565	1160	200/130	580	1230	200/150/100	-	-	 <table border="1"> <thead> <tr> <th></th> <th>A</th> <th>B</th> </tr> </thead> <tbody> <tr> <td>100/60</td> <td>-</td> <td>-</td> </tr> <tr> <td>150/100</td> <td>560</td> <td>1135</td> </tr> <tr> <td>200/130</td> <td>585</td> <td>1235</td> </tr> <tr> <td>200/150/100</td> <td>585</td> <td>1245</td> </tr> </tbody> </table>		A	B	100/60	-	-	150/100	560	1135	200/130	585	1235	200/150/100	585	1245	not available
	A	B																															
100/60	560	1145																															
150/100	565	1160																															
200/130	580	1230																															
200/150/100	-	-																															
	A	B																															
100/60	-	-																															
150/100	560	1135																															
200/130	585	1235																															
200/150/100	585	1245																															

38C-2365C/0

OFFSET TABLES 15°

DRU LAS ES-I 150/100, DRU LAS ES-I 200/130, DRU PV-I 100/60

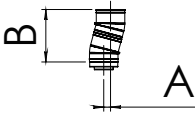
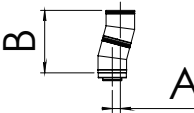
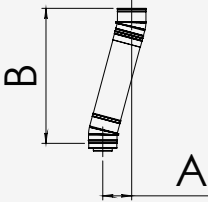
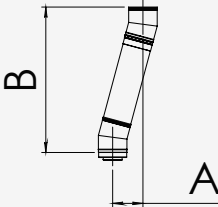
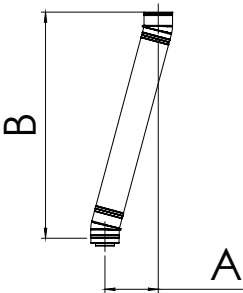
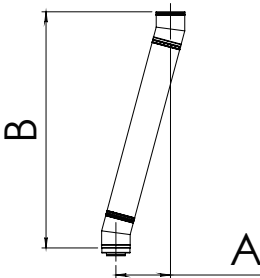
	ribbed bend	segmented bend	smooth bend																														
0	 <table border="1"> <thead> <tr> <th></th> <th>A</th> <th>B</th> </tr> </thead> <tbody> <tr> <td>100/60</td> <td>30</td> <td>280</td> </tr> <tr> <td>150/100</td> <td>35</td> <td>275</td> </tr> <tr> <td>200/130</td> <td>45</td> <td>345</td> </tr> <tr> <td>200/150/100</td> <td>-</td> <td>-</td> </tr> </tbody> </table>		A	B	100/60	30	280	150/100	35	275	200/130	45	345	200/150/100	-	-	 <table border="1"> <thead> <tr> <th></th> <th>A</th> <th>B</th> </tr> </thead> <tbody> <tr> <td>100/60</td> <td>-</td> <td>-</td> </tr> <tr> <td>150/100</td> <td>45</td> <td>330</td> </tr> <tr> <td>200/130</td> <td>45</td> <td>355</td> </tr> <tr> <td>200/150/100</td> <td>-</td> <td>-</td> </tr> </tbody> </table>		A	B	100/60	-	-	150/100	45	330	200/130	45	355	200/150/100	-	-	not available
	A	B																															
100/60	30	280																															
150/100	35	275																															
200/130	45	345																															
200/150/100	-	-																															
	A	B																															
100/60	-	-																															
150/100	45	330																															
200/130	45	355																															
200/150/100	-	-																															
50 cm	 <table border="1"> <thead> <tr> <th></th> <th>A</th> <th>B</th> </tr> </thead> <tbody> <tr> <td>100/60</td> <td>150</td> <td>710</td> </tr> <tr> <td>150/100</td> <td>150</td> <td>710</td> </tr> <tr> <td>200/130</td> <td>160</td> <td>785</td> </tr> <tr> <td>200/150/100</td> <td>-</td> <td>-</td> </tr> </tbody> </table>		A	B	100/60	150	710	150/100	150	710	200/130	160	785	200/150/100	-	-	 <table border="1"> <thead> <tr> <th></th> <th>A</th> <th>B</th> </tr> </thead> <tbody> <tr> <td>100/60</td> <td>-</td> <td>-</td> </tr> <tr> <td>150/100</td> <td>160</td> <td>765</td> </tr> <tr> <td>200/130</td> <td>165</td> <td>790</td> </tr> <tr> <td>200/150/100</td> <td>-</td> <td>-</td> </tr> </tbody> </table>		A	B	100/60	-	-	150/100	160	765	200/130	165	790	200/150/100	-	-	not available
	A	B																															
100/60	150	710																															
150/100	150	710																															
200/130	160	785																															
200/150/100	-	-																															
	A	B																															
100/60	-	-																															
150/100	160	765																															
200/130	165	790																															
200/150/100	-	-																															
100 cm	 <table border="1"> <thead> <tr> <th></th> <th>A</th> <th>B</th> </tr> </thead> <tbody> <tr> <td>100/60</td> <td>280</td> <td>1195</td> </tr> <tr> <td>150/100</td> <td>280</td> <td>1195</td> </tr> <tr> <td>200/130</td> <td>290</td> <td>1260</td> </tr> <tr> <td>200/150/100</td> <td>-</td> <td>-</td> </tr> </tbody> </table>		A	B	100/60	280	1195	150/100	280	1195	200/130	290	1260	200/150/100	-	-	 <table border="1"> <thead> <tr> <th></th> <th>A</th> <th>B</th> </tr> </thead> <tbody> <tr> <td>100/60</td> <td>-</td> <td>-</td> </tr> <tr> <td>150/100</td> <td>290</td> <td>1250</td> </tr> <tr> <td>200/130</td> <td>290</td> <td>1270</td> </tr> <tr> <td>200/150/100</td> <td>-</td> <td>-</td> </tr> </tbody> </table>		A	B	100/60	-	-	150/100	290	1250	200/130	290	1270	200/150/100	-	-	not available
	A	B																															
100/60	280	1195																															
150/100	280	1195																															
200/130	290	1260																															
200/150/100	-	-																															
	A	B																															
100/60	-	-																															
150/100	290	1250																															
200/130	290	1270																															
200/150/100	-	-																															

38C-2365D/0

DRU SERVICE WEBSITE

We would be happy to refer you to our technical website. A website containing comprehensive technical specifications on all of the products from DRU. Websites is available in several languages:

- www.druservice.co.uk, for all business partners in United Kingdom (language: English)
- www.druservice.com, for all other business partners (languages: German-English-French)

Our Service website is geared toward professional users. Comprehensive information can be found using the different menus, including the following:

- Fireplaces and stoves
 - o Item numbers
 - o Drawings
 - o Operating instructions
 - o Installation instructions (Video Assist and My Flue Assist)
 - o Technical specifications
- Spare parts lists
- Accessories
- Materials on flue gas
- Marketing documents (documentation, ad materials), media library

Furthermore, orders can be placed from the Service website and information regarding prices and delivery times can be accessed. Please contact your supplier's customer service department to request an account.

We are confident that our Service website will optimally help you prepare for and install DRU gas fireplaces.



NOTES



● DRU

The Netherlands
United Kingdom
Belgium

DRU Verwarming B.V.
P.O. Box 1021 | 6920 BA Duiven
Ratio 8 | 6921 RW Duiven
The Netherlands
T. +31 (0)26 - 319 5 319
www.dru.nl

Drugasar Ltd.
Deans Road | Swinton
Manchester | M27 0JH
United Kingdom
T. +44 (0)161 - 793 8700
www.drufire.co.uk



BY APPOINTMENT OF
THE COURT OF THE NETHERLANDS

since
1754



DRU : Member of the Spartherm-Group

www.drufire.com