

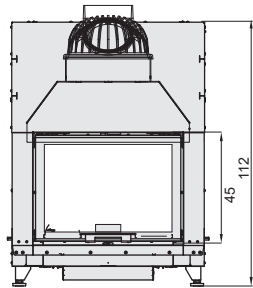



VIOLINO 45x60

Frontansicht · Vue de face
Vista frontale · Front view



Grundriss · Plan d'ensemble
Vista dall'alto · Ground plan

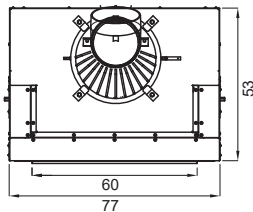

Abgang auch hinten möglich · Sortie du conduit
defumée également possible à l'arrière · Uscita fumi
posteriore possibile · Exhaust at the rear possible

VIOLINO 45x80

Frontansicht · Vue de face
Vista frontale · Front view

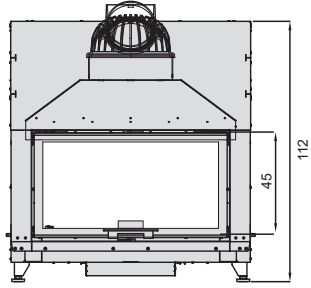

Grundriss · Plan d'ensemble
Vista dall'alto · Ground plan

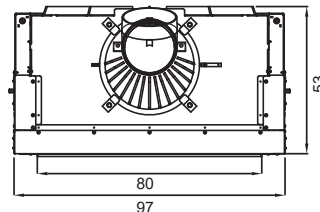

Abgang auch hinten möglich · Sortie du conduit
defumée également possible à l'arrière · Uscita fumi
posteriore possibile · Exhaust at the rear possible

VIOLINO 55x73

Frontansicht · Vue de face
Vista frontale · Front view

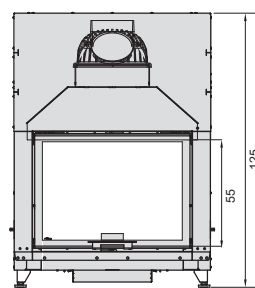

Grundriss · Plan d'ensemble
Vista dall'alto · Ground plan

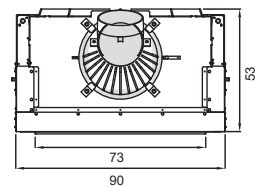

Abgang auch hinten möglich · Sortie du conduit
defumée également possible à l'arrière · Uscita fumi
posteriore possibile · Exhaust at the rear possible

VIOLINO 55x98

Frontansicht · Vue de face
Vista frontale · Front view

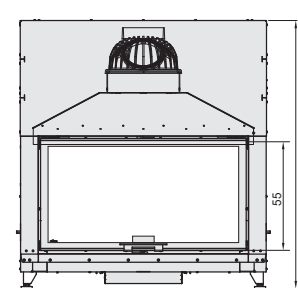

Grundriss · Plan d'ensemble
Vista dall'alto · Ground plan

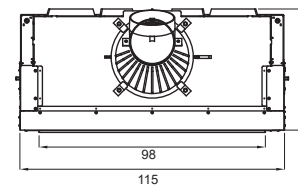

Abgang auch hinten möglich · Sortie du conduit
defumée également possible à l'arrière · Uscita fumi
posteriore possibile · Exhaust at the rear possible

VIOLINO 65x87

Frontansicht · Vue de face
Vista frontale · Front view

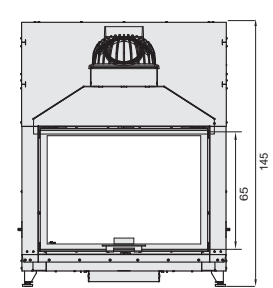

Grundriss · Plan d'ensemble
Vista dall'alto · Ground plan

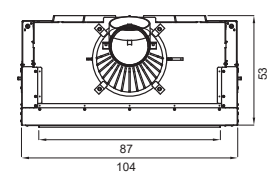

Abgang auch hinten möglich · Sortie du conduit
defumée également possible à l'arrière · Uscita fumi
posteriore possibile · Exhaust at the rear possible

VIOLINO 65x116

Frontansicht · Vue de face
Vista frontale · Front view

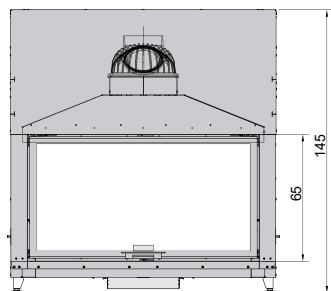

Grundriss · Plan d'ensemble
Vista dall'alto · Ground plan

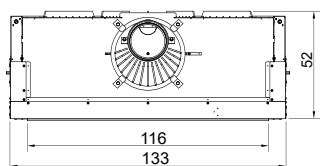

Abgang auch hinten möglich · Sortie du conduit
defumée également possible à l'arrière · Uscita fumi
posteriore possibile · Exhaust at the rear possible

VENUS ECO 510 HK R/L

Frontansicht · Vue de face
Vista frontale · Front view

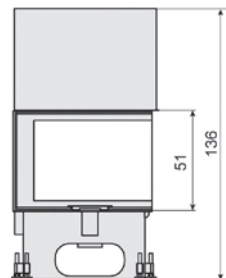

Grundriss · Plan d'ensemble
Vista dall'alto · Ground plan

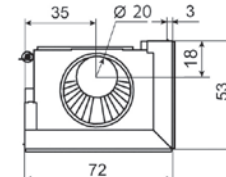

Abgang auch hinten möglich · Sortie du conduit
defumée également possible à l'arrière · Uscita fumi
posteriore possibile · Exhaust at the rear possible

720 ECO R/L

Frontansicht · Vue de face
Vista frontale · Front view

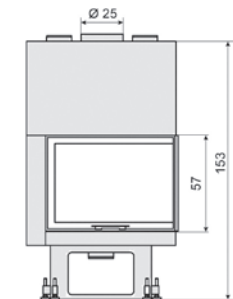

Grundriss · Plan d'ensemble
Vista dall'alto · Ground plan

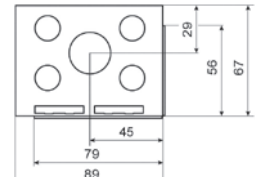

Nicht für Deutschland u. Österreich · Pas pour Allemagne et Autriche
Non per Germania e Austria · Not for Germany and Austria



RII 50x68x42 R/L

Frontansicht · Vue de face
Vista frontale · Front view

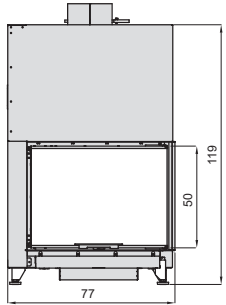

Grundriss · Plan d'ensemble
Vista dall'alto · Ground plan

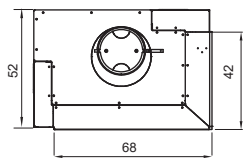

Abgang auch hinten möglich · Sortie du conduit
defumée également possible à l'arrière · Uscita fumi
posteriore possibile · Exhaust at the rear possible

RII 50x68x50 R/L

Frontansicht · Vue de face
Vista frontale · Front view

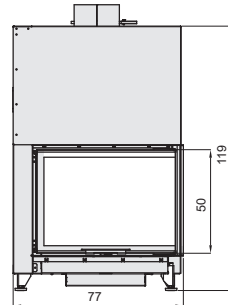

Grundriss · Plan d'ensemble
Vista dall'alto · Ground plan

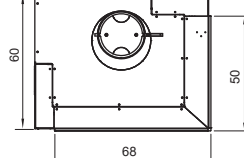

Abgang auch hinten möglich · Sortie du conduit
defumée également possible à l'arrière · Uscita fumi
posteriore possibile · Exhaust at the rear possible

RII 50x80x42 R/L

Frontansicht · Vue de face
Vista frontale · Front view

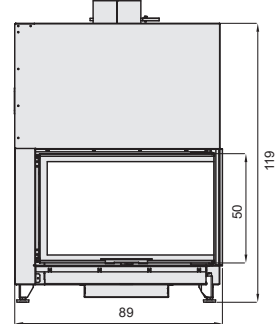

Grundriss · Plan d'ensemble
Vista dall'alto · Ground plan

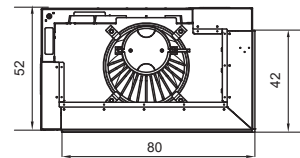

Abgang auch hinten möglich · Sortie du conduit
defumée également possible à l'arrière · Uscita fumi
posteriore possibile · Exhaust at the rear possible

RII 50x80x50 R/L

Frontansicht · Vue de face
Vista frontale · Front view

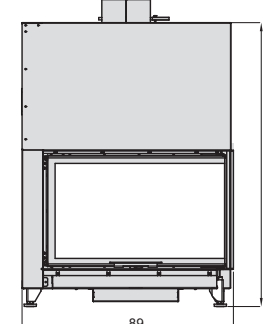

Grundriss · Plan d'ensemble
Vista dall'alto · Ground plan

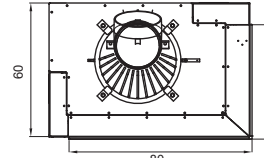

Abgang auch hinten möglich · Sortie du conduit
defumée également possible à l'arrière · Uscita fumi
posteriore possibile · Exhaust at the rear possible

RII 50x100x42 R/L

Frontansicht · Vue de face
Vista frontale · Front view

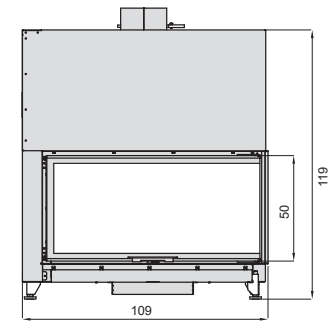

Grundriss · Plan d'ensemble
Vista dall'alto · Ground plan

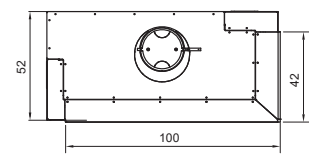

Abgang auch hinten möglich · Sortie du conduit
defumée également possible à l'arrière · Uscita fumi
posteriore possibile · Exhaust at the rear possible

RII 50x100x50 R/L

Frontansicht · Vue de face
Vista frontale · Front view

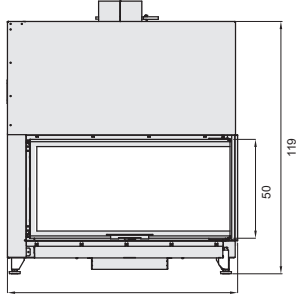

Grundriss · Plan d'ensemble
Vista dall'alto · Ground plan

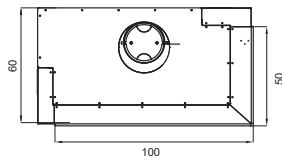

Abgang auch hinten möglich · Sortie du conduit
defumée également possible à l'arrière · Uscita fumi
posteriore possibile · Exhaust at the rear possible

KII 50x68x42

Frontansicht · Vue de face
Vista frontale · Front view

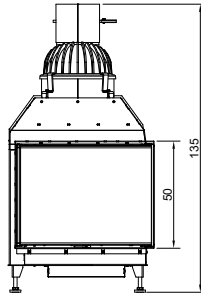

Grundriss · Plan d'ensemble
Vista dall'alto · Ground plan

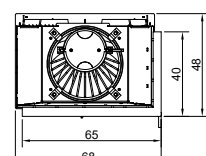

Abgang auch hinten möglich · Sortie du conduit
defumée également possible à l'arrière · Uscita fumi
posteriore possibile · Exhaust at the rear possible

KII 50x68x50

Frontansicht · Vue de face
Vista frontale · Front view

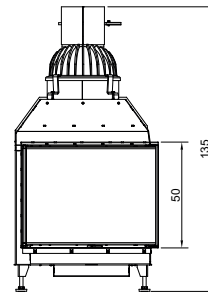

Grundriss · Plan d'ensemble
Vista dall'alto · Ground plan

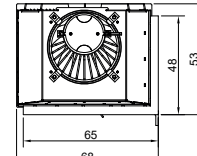

Abgang auch hinten möglich · Sortie du conduit
defumée également possible à l'arrière · Uscita fumi
posteriore possibile · Exhaust at the rear possible

KII 50x80x42

Frontansicht · Vue de face
Vista frontale · Front view

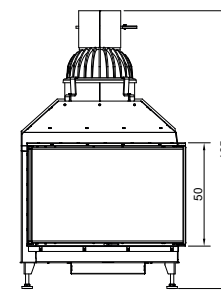

Grundriss · Plan d'ensemble
Vista dall'alto · Ground plan

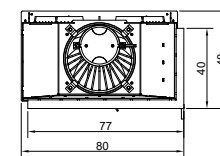

Abgang auch hinten möglich · Sortie du conduit
defumée également possible à l'arrière · Uscita fumi
posteriore possibile · Exhaust at the rear possible

KII 50x80x50

Frontansicht · Vue de face
Vista frontale · Front view

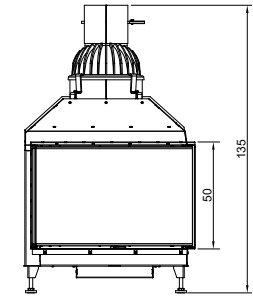

Grundriss · Plan d'ensemble
Vista dall'alto · Ground plan

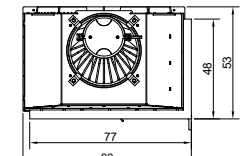

Abgang auch hinten möglich · Sortie du conduit
defumée également possible à l'arrière · Uscita fumi
posteriore possibile · Exhaust at the rear possible



RIII 45x56x46

Frontansicht · Vue de face
Vista frontale · Front view

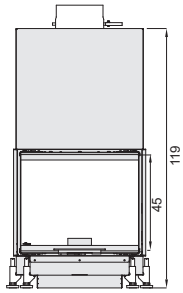

Grundriss · Plan d'ensemble
Vista dall'alto · Ground plan

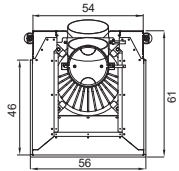

Abgang auch hinten möglich · Sortie du conduit
defumée également possible à l'arrière · Uscita fumi
posteriore possibile · Exhaust at the rear possible

RIII 55x56x46

Frontansicht · Vue de face
Vista frontale · Front view

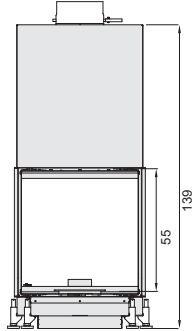

Grundriss · Plan d'ensemble
Vista dall'alto · Ground plan

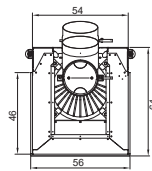

Abgang auch hinten möglich · Sortie du conduit
defumée également possible à l'arrière · Uscita fumi
posteriore possibile · Exhaust at the rear possible

RIII 45x56x60

Frontansicht · Vue de face
Vista frontale · Front view

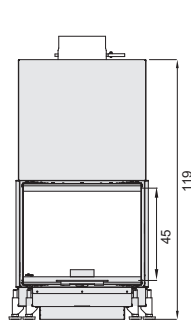

Grundriss · Plan d'ensemble
Vista dall'alto · Ground plan

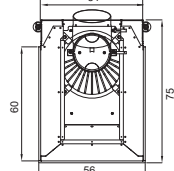

Abgang auch hinten möglich · Sortie du conduit
defumée également possible à l'arrière · Uscita fumi
posteriore possibile · Exhaust at the rear possible

RIII 55x56x60

Frontansicht · Vue de face
Vista frontale · Front view

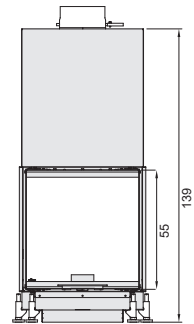

Grundriss · Plan d'ensemble
Vista dall'alto · Ground plan

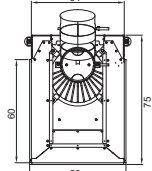

Abgang auch hinten möglich · Sortie du conduit
defumée également possible à l'arrière · Uscita fumi
posteriore possibile · Exhaust at the rear possible

RIII 45x56x80

Frontansicht · Vue de face
Vista frontale · Front view

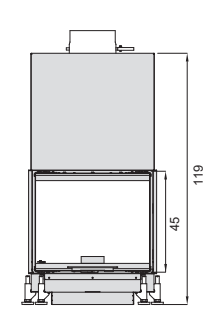

Grundriss · Plan d'ensemble
Vista dall'alto · Ground plan

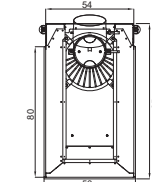

Abgang auch hinten möglich · Sortie du conduit
defumée également possible à l'arrière · Uscita fumi
posteriore possibile · Exhaust at the rear possible

RIII 55x56x80

Frontansicht · Vue de face
Vista frontale · Front view

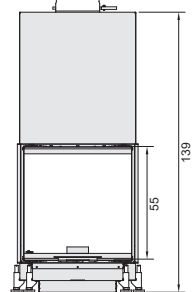

Grundriss · Plan d'ensemble
Vista dall'alto · Ground plan

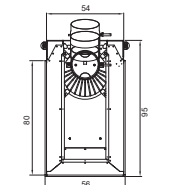

Abgang auch hinten möglich · Sortie du conduit
defumée également possible à l'arrière · Uscita fumi
posteriore possibile · Exhaust at the rear possible

RIII 45x68x46

Frontansicht · Vue de face
Vista frontale · Front view

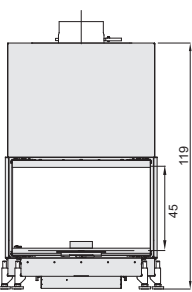

Grundriss · Plan d'ensemble
Vista dall'alto · Ground plan

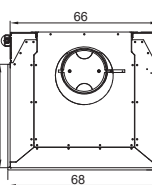

Abgang auch hinten möglich · Sortie du conduit
defumée également possible à l'arrière · Uscita fumi
posteriore possibile · Exhaust at the rear possible

RIII 55x68x46

Frontansicht · Vue de face
Vista frontale · Front view

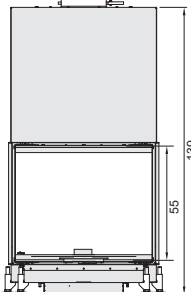

Grundriss · Plan d'ensemble
Vista dall'alto · Ground plan

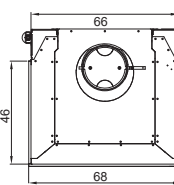

Abgang auch hinten möglich · Sortie du conduit
defumée également possible à l'arrière · Uscita fumi
posteriore possibile · Exhaust at the rear possible

RIII 45x80x46

Frontansicht · Vue de face
Vista frontale · Front view

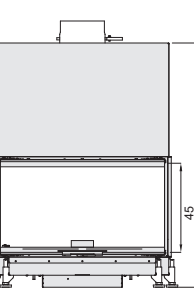

Grundriss · Plan d'ensemble
Vista dall'alto · Ground plan

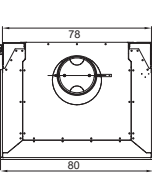

Abgang auch hinten möglich · Sortie du conduit
defumée également possible à l'arrière · Uscita fumi
posteriore possibile · Exhaust at the rear possible

RIII 55x80x46

Frontansicht · Vue de face
Vista frontale · Front view

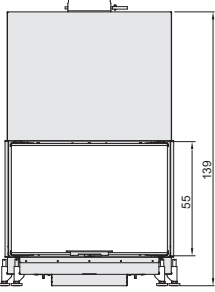

Grundriss · Plan d'ensemble
Vista dall'alto · Ground plan

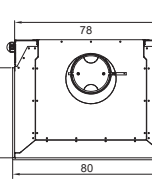

Abgang auch hinten möglich · Sortie du conduit
defumée également possible à l'arrière · Uscita fumi
posteriore possibile · Exhaust at the rear possible

RIII 45x100x46

Frontansicht · Vue de face
Vista frontale · Front view

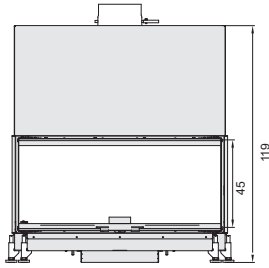

Grundriss · Plan d'ensemble
Vista dall'alto · Ground plan

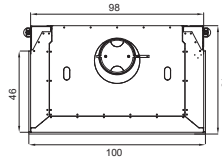

Abgang auch hinten möglich · Sortie du conduit
defumée également possible à l'arrière · Uscita fumi
posteriore possibile · Exhaust at the rear possible

RIII 55x100x46

Frontansicht · Vue de face
Vista frontale · Front view

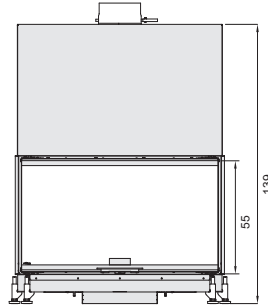

Grundriss · Plan d'ensemble
Vista dall'alto · Ground plan

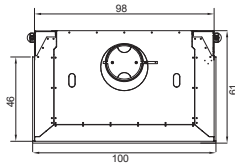

Abgang auch hinten möglich · Sortie du conduit
defumée également possible à l'arrière · Uscita fumi
posteriore possibile · Exhaust at the rear possible

RAS 50x68x42

Frontansicht · Vue de face
Vista frontale · Front view

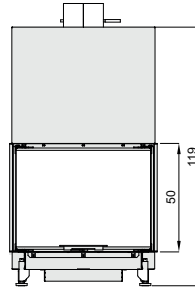

Grundriss · Plan d'ensemble
Vista dall'alto · Ground plan

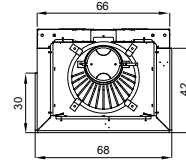

RAS 50x80x42

Frontansicht · Vue de face
Vista frontale · Front view

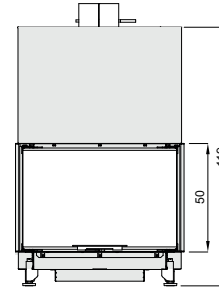

Grundriss · Plan d'ensemble
Vista dall'alto · Ground plan

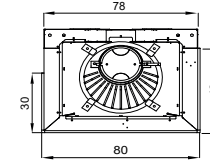

ODEON 270°

Frontansicht · Vue de face
Vista frontale · Front view

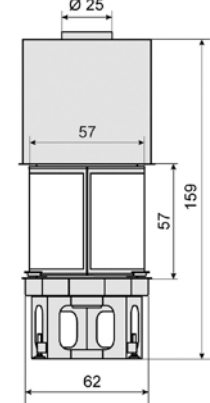

Grundriss · Plan d'ensemble
Vista dall'alto · Ground plan

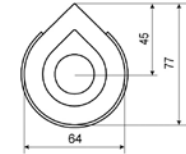

VIOLINO TUNNEL 45x80

Frontansicht · Vue de face
Vista frontale · Front view

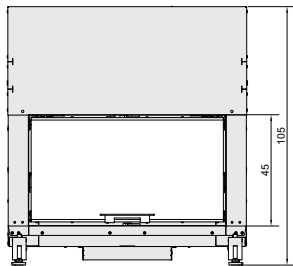

Grundriss · Plan d'ensemble
Vista dall'alto · Ground plan

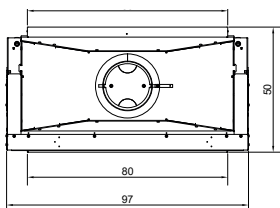

VIOLINO TUNNEL 55x73

Frontansicht · Vue de face
Vista frontale · Front view

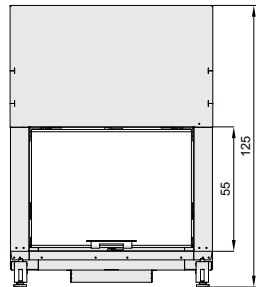

Grundriss · Plan d'ensemble
Vista dall'alto · Ground plan

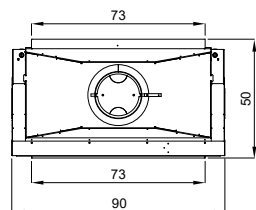

VIOLINO TUNNEL 55x98

Frontansicht · Vue de face
Vista frontale · Front view

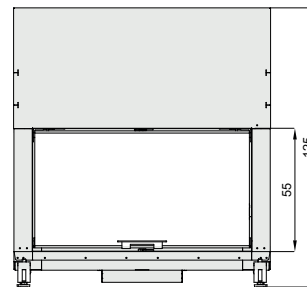

Grundriss · Plan d'ensemble
Vista dall'alto · Ground plan

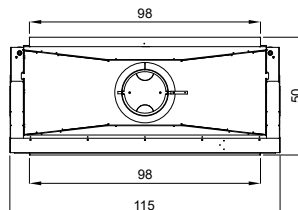

CUBEO®

Frontansicht · Vue de face
Vista frontale · Front view

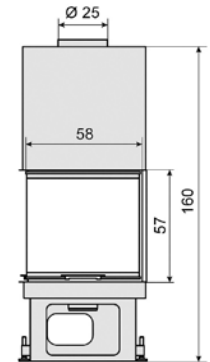

Grundriss · Plan d'ensemble
Vista dall'alto · Ground plan

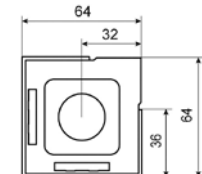

CELTIS

Frontansicht · Vue de face
Vista frontale · Front view

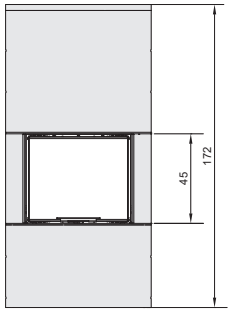

Grundriss · Plan d'ensemble
Vista dall'alto · Ground plan

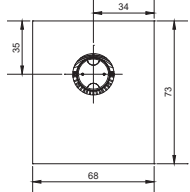

Abgang auch hinten möglich · Sortie du conduit
defumée également possible à l'arrière · Uscita fumi
posteriore possibile · Exhaust at the rear possible

TILIA

Frontansicht · Vue de face
Vista frontale · Front view

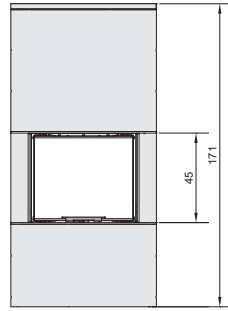

Grundriss · Plan d'ensemble
Vista dall'alto · Ground plan

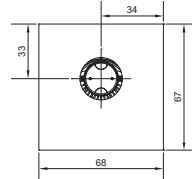

Abgang auch hinten möglich · Sortie du conduit
defumée également possible à l'arrière · Uscita fumi
posteriore possibile · Exhaust at the rear possible



Heat-Line SOE FRONT

Grundriss · Plan d'ensemble
Vista dall'alto · Ground plan

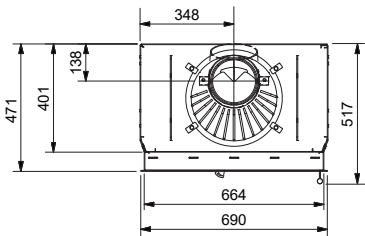

Heat-Line SOE ECK

Grundriss · Plan d'ensemble
Vista dall'alto · Ground plan

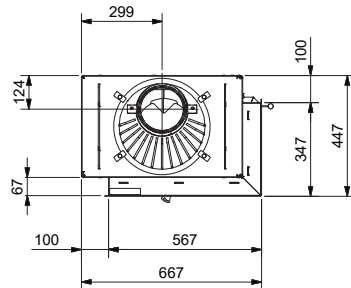

Heat-Line SOE TUNNEL

Grundriss · Plan d'ensemble
Vista dall'alto · Ground plan

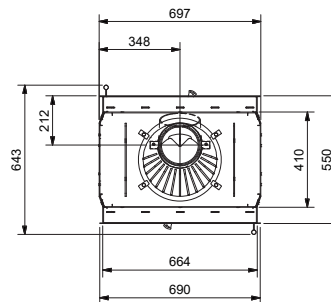

HEAT-LINE KE 36x74

Grundriss · Plan d'ensemble
Vista dall'alto · Ground plan

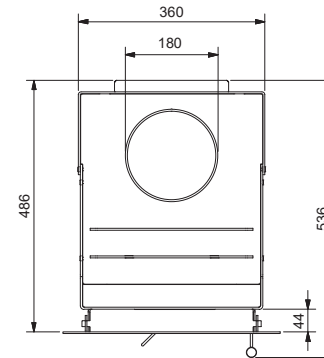

COOKCOOK

Frontansicht · Vue de face
Vista frontale · Front view

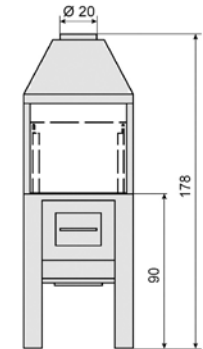

Grundriss · Plan d'ensemble
Vista dall'alto · Ground plan

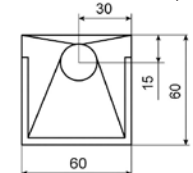



Rüegg Cheminée Schweiz AG

Studbachstrasse 7
8340 Hinwil · Schweiz
Tel. +41 44 938 58 58
info@ruegg.swiss
www.ruegg.swiss

Rüegg Cheminées und Öfen sowie deren Zubehör werden ausschliesslich vom qualifizierten Fachbetrieb angeboten und verkauft.

Technische und Sortimentsänderungen sowie Irrtum vorbehalten.

Les cheminées et poêles Rüegg ainsi que leurs accessoires sont proposés et vendus exclusivement par des revendeurs spécialisés qualifiés.

Sous réserve de modifications techniques et de la gamme de produits, ainsi que d'erreurs.

I camini, le stufe-camino Rüegg e i loro accessori vengono offerti e venduti esclusivamente da rivenditori specializzati e qualificati.

Il fabbricante si riserva il diritto di apportare modifica tecnica relativa alla gamma prodotti nonché a possibili errori presenti.

Rüegg fireplaces and stoves as well as their accessories are exclusively offered and sold by qualified specialist dealers.

We reserve the right to apply technical and product range changes and correct errors.

Designed & Engineered in Switzerland 